

ELECTRICAL

IN THIS CATEGORY

BATTERIES, JUMP STARTERS & CHARGERS (p.3-26)

BEACONS, TORCHES & WORKLIGHTS (p.26-36)

CABLE, WIRE & TUBING (p.37-47)

CAMERAS, SENSORS & TRACKERS (p.47-52)

CHARGING CABLES, PHONE HOLDERS & ACCESSORIES (p.52-55)

FUSES & FUSE ACCESSORIES (p.56-93)

GLOBES & LED & HALOGEN (p.94-96)

LIGHT BARS & DRIVING LIGHTS (p.96-99)

MECHANICAL TESTING EQUIPMENT (p.100-104)

SPECIALISED (p.104-112)

SWITCHES, FLASHERS, RELAYS & HORNS (p.112-140)

TERMINALS & CONNECTORS (p.140-156)

TRAILER CONNECTORS & SUZI COILS (p.157-159)

TRUCK AND TRAILER REFLECTORS & LIGHTS (p.160-182)

UHF RADIOS & ACCESSORIES (p.182-193)

SYDNEY

(02) 9769 1166

114 TOONGABBIE RD

TOONGABBIE NSW 2146

BRISBANE

(07) 5540 7530









8-9/67 Cuthbert Drive

YATALA QLD 4207

SHOP ONLINE

WWW.MRFILTER.COM.AU

Batteries, Jump Starters & Chargers - Batteries









	38B19RS-NS40ZA	NS40ZA Calcium Maintenance free Battery		
	187 (L: mm)	127 (W: mm)	222 (H: mm)	Skinny Terminal
	+ -		Conventional	Standard
	CCA: 340	Amp: 0		
	38B19LS-	NS40ZAL Calcium Maintenance free Battery		
	187 (L: mm)	127 (W: mm)	222 (H: mm)	Skinny Terminal
	- +		Conventional	Standard
	CCA: 340	Amp: 0		
	38B19R-NS40Z	NS40Z Calcium Maintenance free Battery		
	187 (L: mm)	127 (W: mm)	222 (H: mm)	Skinny Terminal
	+ -		Conventional	Standard
	CCA: 340	Amp: 0		
	38B19L-NS40ZL	NS40ZL Calcium Maintenance free Battery		
	187 (L: mm)	127 (W: mm)	222 (H: mm)	Skinny Terminal
	- +		Conventional	Standard
	CCA: 340	Amp: 0		
	50D20L	50D20L Calcium Maintenance free Battery		
	200 (L: mm)	172 (W: mm)	220 (H: mm)	Standard Terminal
	- +		Conventional	Standard
	CCA: 450	Amp: 0		
	85EFR-610	85EFR-610 Calcium Maintenance free Battery		
	229 (L: mm)	173 (W: mm)	203 (H: mm)	Standard Terminal
	+ -		Conventional	Standard
	CCA: 610	Amp: 0		
	EFB55D23R-Q85R	55D23R Q85R Stop Start EFB Calcium Maintenance free Battery		
	231 (L: mm)	172 (W: mm)	220 (H: mm)	Standard Terminal
	+ -		Conventional	Start Stop EFB
	CCA: 670	Amp: 0		
	55D23R	55D23R Calcium Maintenance free Battery		
	231 (L: mm)	172 (W: mm)	220 (H: mm)	Standard Terminal
	+ -		Conventional	Standard
	CCA: 550	Amp: 0		

WWW.MRFILTER.COM.AU









SYDNEY (02) 9769 1166

Mr Filter
EST 1998
TRUCKING EARTHMOVING MINING
SUPPLIES

BRISBANE (07) 5540 7530

	55D23LS	55D23LS Calcium Maintenance free Battery		
	231 (L: mm)	172 (W: mm)	220 (H: mm)	Standard Terminal
	- +		Conventional	Standard
	CCA: 650	Amp: 0		
	55D23LX	55D23LX Calcium Maintenance free Battery		
	231 (L: mm)	172 (W: mm)	220 (H: mm)	Standard Terminal
	- +		Conventional	Standard
	CCA: 550	Amp: 0		
	85DFL550	85DFL550 Calcium Maintenance free Battery		
	231 (L: mm)	172 (W: mm)	200 (H: mm)	Bolt Through
	- +		Conventional	Standard
	CCA: 550	Amp: 0		
	85EFR550-57N	57 No Ledge Calcium Maintenance free Battery		
	231 (L: mm)	172 (W: mm)	203 (H: mm)	Standard Terminal
	+ -		Conventional	Standard
	CCA: 550	Amp: 0		
	85R550-57	57 Calcium Maintenance free Battery		
	231 (L: mm)	172 (W: mm)	203 (H: mm)	Standard Terminal
	+ -		Conventional	Standard
	CCA: 550	Amp: 0		
	85L550-58	58 Calcium Maintenance free Battery		
	231 (L: mm)	172 (W: mm)	203 (H: mm)	Standard Terminal
	- +		Conventional	Standard
	CCA: 550	Amp: 0		
	N43	N43 Calcium Maintenance free Battery		
	236 (L: mm)	133 (W: mm)	204 (H: mm)	Standard Terminal
	+ -		Conventional	Standard
	CCA: 360	Amp: 0		
	46B24RS-NS60RS	NS60RS Calcium Maintenance free Battery		
	237 (L: mm)	128 (W: mm)	220 (H: mm)	Standard Terminal
	+ -		Conventional	Standard
	CCA: 430	Amp: 0		

WWW.MRFILTER.COM.AU

	46B24LS-NS60LS	NS60LS Calcium Maintenance free Battery		
	237 (L: mm)	128 (W: mm)	220 (H: mm)	Standard Terminal
	- +		Conventional	Standard
	CCA: 430	Amp: 0		
	46B24R-NS60R	NS60R Calcium Maintenance free Battery		
	237 (L: mm)	128 (W: mm)	220 (H: mm)	Skinny Terminal
	+ -		Conventional	Standard
	CCA: 430	Amp: 0		
	46B24L-NS60L	NS60L Calcium Maintenance free Battery		
	237 (L: mm)	128 (W: mm)	220 (H: mm)	Skinny Terminal
	- +		Conventional	Standard
	CCA: 430	Amp: 0		
	85DFL-610	85DFL-610 Calcium Maintenance free Battery		
	241 (L: mm)	173 (W: mm)	203 (H: mm)	Bolt Through
	+ -		Conventional	Standard
	CCA: 610	Amp: 0		
	85R620S	85R620S Calcium Maintenance free Battery		
	241 (L: mm)	173 (W: mm)	203 (H: mm)	Standard Terminal
	+ -		Conventional	Standard
	CCA: 620	Amp: 0		
	85L620S	85L620S Calcium Maintenance free Battery		
	241 (L: mm)	173 (W: mm)	203 (H: mm)	Standard Terminal
	- +		Conventional	Standard
	CCA: 620	Amp: 0		
	80D26LX-NS70L	NS70L Calcium Maintenance free Battery		
	258 (L: mm)	172 (W: mm)	225 (H: mm)	Standard Terminal
	- +		Conventional	Standard
	CCA: 600	Amp: 0		
	80D26RX-NS70	NS70 Calcium Maintenance free Battery		
	258 (L: mm)	172 (W: mm)	225 (H: mm)	Standard Terminal
	+ -		Conventional	Standard
	CCA: 600	Amp: 0		

WWW.MRFILTER.COM.AU

SYDNEY (02) 9769 1166

Mr Filter EST 1998
TRUCKING EARTHMOVING MINING
SUPPLIES

BRISBANE (07) 5540 7530

	78-700	78-700 Calcium Maintenance free Battery		
	260 (L: mm)	179 (W: mm)	181 (H: mm)	Front Terminal
	+ -		Conventional	Standard
	CCA: 700	Amp: 0		
	65D	65D Calcium Maintenance free Battery		
	287 (L: mm)	187 (W: mm)	192 (H: mm)	Standard Terminal
	+ -		Conventional	Standard
	CCA: 750	Amp: 0		
	EFB95D31R-T110	95D31R T110 Stop Start EFB Calcium Maintenance free Battery		
	303 (L: mm)	172 (W: mm)	220 (H: mm)	Standard Terminal
	+ -		Conventional	Start Stop EFB
	CCA: 800	Amp: 0		
	EFB95D31L-T110	95D31L T110 Stop Start EFB Calcium Maintenance free Battery		
	303 (L: mm)	172 (W: mm)	220 (H: mm)	Standard Terminal
	- +		Conventional	Start Stop EFB
	CCA: 800	Amp: 0		
	95D31LS-N70ZZL	N70ZZL High Capacity Calcium Maintenance free Battery		
	305 (L: mm)	171 (W: mm)	225 (H: mm)	Standard Terminal
	- +		Conventional	Standard
	CCA: 900	Amp: 0		
	105D31L-N70ZZL	N70ZZL Calcium Maintenance free Battery		
	305 (L: mm)	171 (W: mm)	225 (H: mm)	Standard Terminal
	- +		Conventional	Standard
	CCA: 750	Amp: 0		
	95D31RS-N70ZZ	N70ZZ High Capacity Calcium Maintenance free Battery		
	305 (L: mm)	171 (W: mm)	225 (H: mm)	Standard Terminal
	+ -		Conventional	Standard
	CCA: 900	Amp: 0		
	105D31R-N70ZZ	N70ZZ Calcium Maintenance free Battery		
	305 (L: mm)	171 (W: mm)	225 (H: mm)	Standard Terminal
	+ -		Conventional	Standard
	CCA: 750	Amp: 0		

WWW.MRFILTER.COM.AU

SYDNEY (02) 9769 1166

Mr Filter EST 1998
TRUCKING EARTHMOVING MINING
SUPPLIES

BRISBANE (07) 5540 7530

	G31-1000FT	G31-1000 Calcium Maintenance free Battery		
	332 (L: mm)	174 (W: mm)	236 (H: mm)	Standard Terminal
	- +		Conventional	Standard
	CCA: 1000	Amp: 0		
	G31-1000T-31TMF	G31-1000 31TMF Calcium Maintenance free Battery		
	332 (L: mm)	174 (W: mm)	236 (H: mm)	Bolt Through
	+ -		Conventional	Standard
	CCA: 1000	Amp: 0		
	G31-1000-31MF	G31-1000 31MF Calcium Maintenance free Battery		
	332 (L: mm)	174 (W: mm)	236 (H: mm)	Standard Terminal
	+ -		Conventional	Standard
	CCA: 1000	Amp: 0		
	N100	N100 Calcium Maintenance free Battery		
	409 (L: mm)	174 (W: mm)	234 (H: mm)	Standard Terminal
	+ -		Conventional	Standard
	CCA: 830	Amp: 0		
	N100L	N100L Calcium Maintenance free Battery		
	409 (L: mm)	174 (W: mm)	234 (H: mm)	Standard Terminal
	- +		Conventional	Standard
	CCA: 830	Amp: 0		
	N120EN	N120EN Calcium Maintenance free Battery		
	505 (L: mm)	183 (W: mm)	235 (H: mm)	Standard Terminal
	+ -		Conventional	Standard
	CCA: 900	Amp: 0		
	N120	N120 Calcium Maintenance free Battery		
	505 (L: mm)	183 (W: mm)	235 (H: mm)	Standard Terminal
	- +		Conventional	Standard
	CCA: 870	Amp: 0		
	N150	N150 Calcium Maintenance free Battery		
	506 (L: mm)	215 (W: mm)	233 (H: mm)	Standard Terminal
	- +		Conventional	Standard
	CCA: 1000	Amp: 0		

WWW.MRFILTER.COM.AU

SYDNEY (02) 9769 1166

Mr Filter EST 1998
TRUCKING EARTHMOVING MINING
SUPPLIES

BRISBANE (07) 5540 7530



	N200	N200 Calcium Maintenance free Battery		
	509 (L: mm)	274 (W: mm)	246 (H: mm)	Standard Terminal
	- +		Conventional	Standard
	CCA: 1200	Amp: 0		
	N200CAT	N200CAT High Capacity Calcium Maintenance free Battery		
	509 (L: mm)	267 (W: mm)	246 (H: mm)	Standard Terminal
	- +		Marine and Leisure	Deep Cycle
	CCA: 1450	Amp: 0		
	N150EN	N150 High Capacity Calcium Maintenance free Battery		
	514 (L: mm)	223 (W: mm)	225 (H: mm)	Standard Terminal
	+ -		Conventional	Standard
	CCA: 1050	Amp: 0		
	N200EN	N200 Calcium Maintenance free Battery		
	518 (L: mm)	273 (W: mm)	235 (H: mm)	Standard Terminal
	+ -		Conventional	Standard
	CCA: 1200	Amp: 0		
	54437-DIN44LH	DIN44LH Din Series Calcium Maintenance free Battery		
	207 (L: mm)	173 (W: mm)	190 (H: mm)	Standard Terminal
	- +		Conventional	Standard
	CCA: 400	Amp: 0		
	54317-DIN44L	DIN44L Din Series Calcium Maintenance free Battery		
	207 (L: mm)	173 (W: mm)	175 (H: mm)	Standard Terminal
	- +		Conventional	Standard
	CCA: 360	Amp: 0		
	EFB55D23L-Q85	55D23L Q85 Stop Start EFB Calcium Maintenance free Battery		
	231 (L: mm)	172 (W: mm)	220 (H: mm)	Standard Terminal
	- +		Conventional	Start Stop EFB
	CCA: 670	Amp: 0		
	55530-DIN55LH	DIN55LH Din Series Calcium Maintenance free Battery		
	242 (L: mm)	172 (W: mm)	190 (H: mm)	Standard Terminal
	- +		Conventional	Standard
	CCA: 500	Amp: 0		

WWW.MRFILTER.COM.AU

SYDNEY (02) 9769 1166

Mr Filter EST 1998
TRUCKING EARTHMOVING MINING
SUPPLIES

BRISBANE (07) 5540 7530









	55520-DIN55R	DIN55R Din Series Calcium Maintenance free Battery		
	242 (L: mm)	172 (W: mm)	175 (H: mm)	Standard Terminal
	+ -		Conventional	Standard
	CCA: 500	Amp: 0		
	55519-DIN55L	DIN55L Din Series Calcium Maintenance free Battery		
	242 (L: mm)	172 (W: mm)	175 (H: mm)	Standard Terminal
	- +		Conventional	Standard
	CCA: 500	Amp: 0		
	VRL260-DIN55LH	DIN55LH Din Series Stop Start AGM Calcium Maintenance free Battery		
	242 (L: mm)	174 (W: mm)	190 (H: mm)	Standard Terminal
	- +		Conventional	AGM
	CCA: 640	Amp: 0		
	VRL370-DIN66LH	DIN66LH Din Series Stop Start AGM Calcium Maintenance free Battery		
	275 (L: mm)	174 (W: mm)	190 (H: mm)	Standard Terminal
	- +		Conventional	AGM
	CCA: 760	Amp: 0		
	56639-DIN66RH	DIN66RH Din Series Calcium Maintenance free Battery		
	276 (L: mm)	172 (W: mm)	190 (H: mm)	Standard Terminal
	+ -		Conventional	Standard
	CCA: 700	Amp: 0		
	56638-DIN66LH	DIN66LH Din Series Calcium Maintenance free Battery		
	276 (L: mm)	172 (W: mm)	190 (H: mm)	Standard Terminal
	- +		Conventional	Standard
	CCA: 700	Amp: 0		
	56319-DIN66R	DIN66R Din Series Calcium Maintenance free Battery		
	276 (L: mm)	172 (W: mm)	175 (H: mm)	Standard Terminal
	+ -		Conventional	Standard
	CCA: 670	Amp: 0		
	56318-DIN66L	DIN66L Din Series Calcium Maintenance free Battery		
	276 (L: mm)	172 (W: mm)	175 (H: mm)	Standard Terminal
	- +		Conventional	Standard
	CCA: 670	Amp: 0		

WWW.MRFILTER.COM.AU

SYDNEY (02) 9769 1166

Mr Filter EST 1998
TRUCKING (EARTHMOVING MINING)
SUPPLIES

BRISBANE (07) 5540 7530

	VRL480-DIN77LH	DIN77LH Din Series Stop Start AGM Calcium Maintenance free Battery		
	314 (L: mm)	174 (W: mm)	190 (H: mm)	Standard Terminal
	- +		Conventional	AGM
	CCA: 800	Amp: 0		
	58044-DIN77RH	DIN77RH Din Series Calcium Maintenance free Battery		
	315 (L: mm)	172 (W: mm)	190 (H: mm)	Standard Terminal
	+ -		Conventional	Standard
	CCA: 750	Amp: 0		
	58043-DIN77LH	DIN77LH Din Series Calcium Maintenance free Battery		
	315 (L: mm)	172 (W: mm)	190 (H: mm)	Standard Terminal
	- +		Conventional	Standard
	CCA: 750	Amp: 0		
	57539-DIN77L	DIN77L Din Series Calcium Maintenance free Battery		
	315 (L: mm)	172 (W: mm)	175 (H: mm)	Standard Terminal
	- +		Conventional	Standard
	CCA: 750	Amp: 0		
	60044-DIN88LH	DIN88LH Din Series Calcium Maintenance free Battery		
	351 (L: mm)	172 (W: mm)	190 (H: mm)	Standard Terminal
	- +		Conventional	Standard
	CCA: 880	Amp: 0		
	58588-DIN88L	DIN88L Din Series Calcium Maintenance free Battery		
	351 (L: mm)	172 (W: mm)	175 (H: mm)	Standard Terminal
	- +		Conventional	Standard
	CCA: 780	Amp: 0		
	VRL590-DIN88LH	DIN88LH Din Series Stop Start AGM Calcium Maintenance free Battery		
	353 (L: mm)	174 (W: mm)	190 (H: mm)	Standard Terminal
	- +		Conventional	AGM
	CCA: 850	Amp: 0		
	L6-DIN110	DIN110 Din Series Calcium Maintenance free Battery		
	394 (L: mm)	175 (W: mm)	190 (H: mm)	Standard Terminal
	- +		Conventional	Standard
	CCA: 900	Amp: 0		

WWW.MRFILTER.COM.AU

SYDNEY (02) 9769 1166

Mr Filter EST 1998
TRUCKING EARTHMOVING MINING
SUPPLIES

BRISBANE (07) 5540 7530





	VRL6105-DIN110	DIN110 Din Series Stop Start AGM Calcium Maintenance free Battery		
	394 (L: mm)	175 (W: mm)	190 (H: mm)	Standard Terminal
	- +		Conventional	AGM
	CCA: 950	Amp: 0		
	U1R-350	U1R-350 Calcium Maintenance free Battery		
	197 (L: mm)	130 (W: mm)	186 (H: mm)	Bolt Through
	- +		Lawn and Garden	Standard
	CCA: 350	Amp: 0		
	U1-350	U1-350 Calcium Maintenance free Battery		
	197 (L: mm)	130 (W: mm)	186 (H: mm)	Bolt Through
	+ -		Lawn and Garden	Standard
	CCA: 350	Amp: 0		
	DCN200	DCN200 Deep Cycle Calcium Maintenance free Battery		
	509 (L: mm)	267 (W: mm)	242 (H: mm)	Standard Terminal
	- +		Marine and Leasure	Deep Cycle
	CCA: 1000	Amp: 210		
	DCN150	DCN150 Deep Cycle Calcium Maintenance free Battery		
	514 (L: mm)	223 (W: mm)	255 (H: mm)	Standard Terminal
	- +		Marine and Leasure	Deep Cycle
	CCA: 1000	Amp: 150		
	DCM31	DCM31 Deep Cycle Calcium Maintenance free Battery		
	332 (L: mm)	172 (W: mm)	221 (H: mm)	Dual Terminal
	+ -		Marine and Leasure	Deep Cycle
	CCA: 800	Amp: 120		
	DCM27	DCM27 Deep Cycle Calcium Maintenance free Battery		
	305 (L: mm)	172 (W: mm)	221 (H: mm)	Dual Terminal
	+ -		Marine and Leasure	Deep Cycle
	CCA: 680	Amp: 100		
	DCM24	DCM24 Deep Cycle Calcium Maintenance free Battery		
	332 (L: mm)	172 (W: mm)	221 (H: mm)	Dual Terminal
	+ -		Marine and Leasure	Deep Cycle
	CCA: 600	Amp: 82		

WWW.MRFILTER.COM.AU



SYDNEY (02) 9769 1166

Mr Filter
EST 1998
TRUCKING (EARTHMOVING MINING)
SUPPLIES

BRISBANE (07) 5540 7530

	N150CAT	N150CAT High Capacity Calcium Maintenance free Battery		
	506 (L: mm)	215 (W: mm)	233 (H: mm)	Standard Terminal
	- +			
	CCA: 1200	Amp: 0	Marine and Leasure	Deep Cycle
	M31	M31 Calcium Maintenance free Battery		
	330 (L: mm)	171 (W: mm)	225 (H: mm)	Dual Terminal
	+ -			
	CCA: 930	Amp: 0	Marine and Leasure	Deep Cycle
	M27	M27 Calcium Maintenance free Battery		
	305 (L: mm)	171 (W: mm)	225 (H: mm)	Dual Terminal
	+ -			
	CCA: 750	Amp: 0	Marine and Leasure	Deep Cycle
	M24	M24 Calcium Maintenance free Battery		
	258 (L: mm)	173 (W: mm)	226 (H: mm)	Dual Terminal
	+ -			
	CCA: 650	Amp: 0	Marine and Leasure	Deep Cycle
	D31A	D31A Optima Deep Cycle AGM Dual Purpose Battery		
	325 (L: mm)	166 (W: mm)	238 (H: mm)	Standard Terminal
	+ -			
	CCA: 900	Amp: 75	Marine and Leasure	AGM and Deep Cycle
	D27F	D27F Optima Deep Cycle AGM Dual Purpose Battery		
	305 (L: mm)	172 (W: mm)	225 (H: mm)	Standard Terminal
	- +			
	CCA: 800	Amp: 66	Marine and Leasure	AGM and Deep Cycle
	D35	D35 Optima Deep Cycle AGM Dual Purpose Battery		
	238 (L: mm)	170 (W: mm)	195 (H: mm)	Standard Terminal
	- +			
	CCA: 650	Amp: 48	Marine and Leasure	AGM and Deep Cycle
	D34	D34 Optima Deep Cycle AGM Dual Purpose Battery		
	254 (L: mm)	173 (W: mm)	199 (H: mm)	Standard Terminal
	+ -			
	CCA: 750	Amp: 55	Marine and Leasure	AGM and Deep Cycle

WWW.MRFILTER.COM.AU









	D31M	D31M Optima Marine Dual Purpose Battery		
	308 (L: mm)	172 (W: mm)	225 (H: mm)	Dual Terminal
	+ -		Marine and Leasure	AGM and Deep Cycle
	CCA: 900	Amp: 77		
	D27M	D27M Optima Marine Dual Purpose Battery		
	308 (L: mm)	172 (W: mm)	225 (H: mm)	Dual Terminal
	+ -		Marine and Leasure	AGM and Deep Cycle
	CCA: 800	Amp: 66		
	34M	34M Optima Marine Dual Purpose Battery		
	254 (L: mm)	173 (W: mm)	201 (H: mm)	Dual Terminal
	+ -		Marine and Leasure	AGM and Deep Cycle
	CCA: 800	Amp: 50		
	D34M	D34M Optima Marine AGM Battery		
	254 (L: mm)	173 (W: mm)	201 (H: mm)	Dual Terminal
	+ -		Marine and Leasure	AGM
	CCA: 750	Amp: 55		
	MBTX30UHD	MBTX30UHD Motorbike Battery		
	166 (L: mm)	126 (W: mm)	175 (H: mm)	Bolt Through
	- +		Motorbike	Standard
	CCA: 440	Amp: 0		
	MBTX20UHD	MBTX20UHD Motorbike Battery		
	175 (L: mm)	87 (W: mm)	155 (H: mm)	Bolt Through
	- +		Motorbike	Standard
	CCA: 320	Amp: 0		
	MBYZ16HD	MBYZ16HD Motorbike Battery		
	151 (L: mm)	87 (W: mm)	145 (H: mm)	Bolt Through
	- +		Motorbike	Standard
	CCA: 260	Amp: 0		
	MBTX12U	MBTX12U Motorbike Battery		
	151 (L: mm)	87 (W: mm)	130 (H: mm)	Bolt Through
	- +		Motorbike	Standard
	CCA: 200	Amp: 0		

WWW.MRFILTER.COM.AU







SYDNEY (02) 9769 1166

Mr Filter
EST 1998
TRUCKING EARTHMOVING MINING
SUPPLIES

BRISBANE (07) 5540 7530

	MBTZ10S	MBTZ10S Motorbike Battery		
	151 (L: mm)	87 (W: mm)	95 (H: mm)	Bolt Through
	- +		Motorbike	Standard
	CCA: 190	Amp: 0		
	MBTX9U	MBTX9U Motorbike Battery		
	151 (L: mm)	87 (W: mm)	110 (H: mm)	Bolt Through
	- +		Motorbike	Standard
	CCA: 160	Amp: 0		
	MBTZ7S	MBTZ7S Motorbike Battery		
	114 (L: mm)	70 (W: mm)	107 (H: mm)	Bolt Through
	- +		Motorbike	Standard
	CCA: 130	Amp: 0		
	MBTX4U	MBTX4U Motorbike Battery		
	114 (L: mm)	70 (W: mm)	87 (H: mm)	Bolt Through
	- +		Motorbike	Standard
	CCA: 70	Amp: 0		
	B3121	B3121 Braille Advanced AGM Battery		
	168 (L: mm)	132 (W: mm)	173 (H: mm)	Other
	- +		Specialised	Other
	CCA: 1380	Amp: 0		
	B2015	B2015 Braille Advanced AGM Battery		
	173 (L: mm)	86 (W: mm)	155 (H: mm)	Other
	- +		Specialised	Other
	CCA: 1067	Amp: 0		
	B14115	B14115 Braille Advanced AGM Battery		
	147 (L: mm)	86 (W: mm)	147 (H: mm)	Other
	+ -		Specialised	Other
	CCA: 904	Amp: 0		
	B168LC	B168LC Braille Lithium Battery		
	258 (L: mm)	80 (W: mm)	156 (H: mm)	Other
	+ -		Specialised	Other
	CCA: 2325	Amp: 0		

	B128L	B128L Braille Lithium Battery		
	258 (L: mm)	80 (W: mm)	156 (H: mm)	Other
	+ -		Specialised	Other
	CCA: 1698	Amp: 0		
	G30C	G30C Braille Lithium Battery		
	174 (L: mm)	132 (W: mm)	177 (H: mm)	Other
	- +		Specialised	Other
	CCA: 647	Amp: 0		
	G20	G20 Braille Lithium Battery		
	180 (L: mm)	76 (W: mm)	159 (H: mm)	Other
	- +		Specialised	Other
	CCA: 967	Amp: 0		
	PC2150MJT	PC2150MJT Odyssey GM Battery G31-1000		
	330 (L: mm)	173 (W: mm)	329 (H: mm)	Other
	+ -		Specialised	Other
	CCA: 1150	Amp: 0		
	PC1750-65	PC1750-65 Odyssey GM Battery Ford F250		
	300 (L: mm)	183 (W: mm)	189 (H: mm)	Other
	+ -		Specialised	Other
	CCA: 950	Amp: 0		
	PC1700	PC1700 Odyssey GM Battery 4WD, Trucks		
	330 (L: mm)	173 (W: mm)	329 (H: mm)	Other
	- +		Specialised	Other
	CCA: 810	Amp: 0		
	PC1500	PC1500 Odyssey GM Battery V8 Trucks		
	276 (L: mm)	178 (W: mm)	199 (H: mm)	Other
	+ -		Specialised	Other
	CCA: 850	Amp: 0		
	PC1400-35	PC1400-35 Odyssey GM Battery 85R-550		
	240 (L: mm)	174 (W: mm)	221 (H: mm)	Other
	- +		Specialised	Other
	CCA: 850	Amp: 0		

	PC1400-25	PC1400-25 Odyssey GM Battery 85R-550		
	240 (L: mm)	174 (W: mm)	221 (H: mm)	Other
	+ -		Specialised	Other
	CCA: 850	Amp: 0		
	PC1200MJT	PC1200MJT Odyssey GM Battery V8		
	200 (L: mm)	169 (W: mm)	173 (H: mm)	Other
	- +		Specialised	Other
	CCA: 540	Amp: 0		
	PC925MJT	PC925MJT Odyssey GM Battery 6 Cylinder		
	168 (L: mm)	179 (W: mm)	148 (H: mm)	Other
	- +		Specialised	Other
	CCA: 330	Amp: 0		
	PC680MJT	PC680MJT Odyssey GM Battery 4 Cylinder		
	238 (L: mm)	170 (W: mm)	195 (H: mm)	Other
	- +		Specialised	Other
	CCA: 650	Amp: 48		
	HT12V70D	HT12V220D Gel Battery		
	261 (L: mm)	169 (W: mm)	216 (H: mm)	Bolt Through
	+ -		Specialised	Other
	CCA: 0	Amp: 70		
	RED35	RED 35 Optima AGM Battery		
	238 (L: mm)	173 (W: mm)	199 (H: mm)	Standard Terminal
	- +		Specialised	AGM
	CCA: 800	Amp: 0		
	RED34R	RED 34R Optima AGM Battery		
	254 (L: mm)	173 (W: mm)	199 (H: mm)	Standard Terminal
	- +		Specialised	AGM
	CCA: 800	Amp: 0		
	RED34	RED 34 Optima AGM Battery		
	254 (L: mm)	173 (W: mm)	199 (H: mm)	Standard Terminal
	+ -		Specialised	AGM
	CCA: 800	Amp: 0		

WWW.MRFILTER.COM.AU

SYDNEY (02) 9769 1166

Mr Filter EST 1998
TRUCKING EARTHMOVING MINING
SUPPLIES

BRISBANE (07) 5540 7530

	RED25	RED 25 Optima AGM Battery		
	238 (L: mm)	173 (W: mm)	199 (H: mm)	Standard Terminal
	+ -		Specialised	AGM
	CCA: 720	Amp: 0		
	RED78	RED78 Optima AGM Battery		
	254 (L: mm)	185 (W: mm)	184 (H: mm)	Front Terminal
	+ -		Specialised	AGM
	CCA: 800	Amp: 0		
	RED34-78	RED 34/78 Optima AGM Battery		
	254 (L: mm)	173 (W: mm)	199 (H: mm)	Front and Top
	+ -		Specialised	AGM
	CCA: 800	Amp: 0		
	RED75-25	RED 75/25 Optima AGM Battery		
	238 (L: mm)	173 (W: mm)	199 (H: mm)	Front and Top
	+ -		Specialised	AGM
	CCA: 720	Amp: 0		
	RED 6V	RED 6V Optima AGM Battery		
	254 (L: mm)	90 (W: mm)	208 (H: mm)	Standard Terminal
	- +		Specialised	AGM
	CCA: 800	Amp: 0		
	NPDC12350	NPDC12350 High Power AGM Deep Cycle Battery		
	195 (L: mm)	130 (W: mm)	167 (H: mm)	Bolt Through
	+ -		Specialised	AGM
	CCA: 0	Amp: 35		
	NPDC12260	NPDC12260 High Power AGM Deep Cycle Battery		
	167 (L: mm)	176 (W: mm)	125 (H: mm)	Bolt Through
	- +		Specialised	AGM
	CCA: 0	Amp: 26		
	NPDC12220	NPDC12220 High Power AGM Deep Cycle Battery		
	181 (L: mm)	77 (W: mm)	167 (H: mm)	Bolt Through
	- +		Specialised	AGM
	CCA: 0	Amp: 22		

WWW.MRFILTER.COM.AU

SYDNEY (02) 9769 1166

Mr Filter EST 1998
TRUCKING | EARTHMOVING | MINING
SUPPLIES

BRISBANE (07) 5540 7530

	NPD122300	NPD122300 High Power AGM Battery		
	532 (L: mm)	207 (W: mm)	218 (H: mm)	Bolt Through
	- +		Specialised	AGM
	CCA: 0	Amp: 230		
	NP1270	NP1270 High Power AGM Battery		
	152 (L: mm)	65 (W: mm)	100 (H: mm)	Clip Terminal
	- +		Specialised	AGM
	CCA: 0	Amp: 7		
	NP1250	NP1250 High Power AGM Battery		
	90 (L: mm)	70 (W: mm)	101 (H: mm)	Clip Terminal
	+ -		Specialised	AGM
	CCA: 0	Amp: 5		
	HT12V220D	HT12V220D Dual Purpose AGM		
	522 (L: mm)	240 (W: mm)	238 (H: mm)	Bolt Through
	- +		Specialised	AGM
	CCA: 1250	Amp: 220		
	HT12V125D	HT12V125D Dual Purpose AGM		
	329 (L: mm)	172 (W: mm)	223 (H: mm)	Bolt Through
	+ -		Specialised	AGM
	CCA: 900	Amp: 125		
	HT12V105D	HT12V105D Dual Purpose AGM		
	307 (L: mm)	169 (W: mm)	209 (H: mm)	Bolt Through
	+ -		Specialised	AGM
	CCA: 800	Amp: 105		
	HT12V85D	HT12V85D Dual Purpose AGM		
	260 (L: mm)	168 (W: mm)	210 (H: mm)	Bolt Through
	+ -		Specialised	AGM
	CCA: 600	Amp: 85		

Batteries, Jump Starters & Chargers - Battery Accessories



Spring Clip 16-20Mm Id
20173



Electronic Box
3853675



7 Terminal Junction Box (1)
57800



8 Way Waterproof Junction Box
57810



Battery Terminal Insulator Red
ACX3134



Battery Terminal Insulator Black
ACX3135



Boot Battery Terminal
ECH2919B



Boot Battery Terminal 50-
ECH2919R



Battery Hold Down Clamp
MA98100



Battery Isolator Terminal
BT11S



Battery Terminal Covers
ma1005-2



Battery Terminal Covers
ma1006-2



Battery Terminal Felt Washer Kit (Pair)
MA22FBL1



Battery Discharge Pro
AA0262



Battery Tray Small Steel
MA98110



Battery Tray Large Steel
MA98111



Battery Box Small
MA98115



Battery Box Medium
MA98116



Battery Box Large
MA98117



Battery Power Box
MA98121

WWW.MRFILTER.COM.AU

SYDNEY (02) 9769 1166

Mr Filter EST 1998
TRUCKING EARTHMOVING MINING
SUPPLIES

BRISBANE (07) 5540 7530



Battery Box Large
BB0015



Powertech Battery Box
HB8504



Battery Clips Matson
MA98160



Electrical Clip Assortment
RG2885

Batteries, Jump Starters & Chargers - Chargers



12V - 18V Multi Voltage Rapid 6-Battery
114752



Bosch Charger
1600A00N5M



Dual Bay Simultaneous Rapid Charger
164201



12V & 18V Super Charger
166448



12V Li-ion Cordless 38m 3 Plane Laser
186235



Battery charger C 4-22 240V
2388397



Charger Dual Holder No AC
2U0020



CTEK Battery Charger 12V 20AMP
40-315



18V Battery Charger
7831



4-Amp 12V 4 Stage Battery
AC040



8amp 12v 8 Stage Battery
AC080



Projecta 900MA 12V Charger
AC150



Battery Charger 6Amp
AC600



Battery Charger 8Amp
AC800



12V Smart Charger 1.5 Amp
AE150E



BC-460 Durst Battery Charger
BC-460

WWW.MRFILTER.COM.AU



Desktop Charging Cradle - Suit Tx680
BCD007



Charging Cradle - Suit Tx685/Tx6155/Tx6160
BCD020



Dual Desktop Charging Cradle
BCD021



DC-DC In-Vehicle Battery
BCDC1220



Redarc In-Vehicle Battery
BCDC1225D



Dc Battery Charger 12/24V 40Amp
BCDC1240D



12V 50A DC to DC Battery
BCDC1250D



DC To DC In-Vehicle Battery
BCDC2420LV



Core25 In Cabin DC Charger
BCDCN1225



Manager30 S3 Battery
BMS1230S3



12/24V DC In-Car Vehicle Charger
BCV013



In-Car Vehicle Charger
BCV012



BOP Battery Charger
BPC-A



Victron Blue Smart 12V 15A Battery
BPC121531014R



Multivolt Smart Battery
CH20101



Cigarette Lighter Accessory
CH21309



Battery Charger 12v 2.8amp
CH4



Noco Genius 8 Stage Battery
G15000AU



Genius Battery Charger 12/24V
G26000AU



Genius V3 Battery Charger
GENIUS1AU

WWW.MRFILTER.COM.AU

SYDNEY (02) 9769 1166

Mr Filter
EST 1998
TRUCKING EARTHMOVING MINING
SUPPLIES

BRISBANE (07) 5540 7530



Battery Charger 6/12/24V 8 Stage 25A
GENIUSPRO25



Battery Charger 6/12/24V 8 Stage 50A
GENIUSPRO50



Projecta Battery Charger 6/12/24V 21A
HDBC35



Projecta Battery Charger 6/12/24V 40A
HDBM4000



Axis HDC-AX-F Cable Adaptor
HDC-AX-F



Remote Jump Start Plug
HM7546P



Magcode Power Outlet 12V
HMPS12VKIT



Smart 25A Battery Charger
HU6558



Bcdc Battery Charger Mounting
IBCS002



Macnaught Lithium-Ion Charger
L-BGCLI



12V - 18V Multi Voltage Rapid Battery
M12-18FC



In Car Charger 12 - 18V
M1218AC



18V Li-Ion 6 Bay Battery Sequential Charger
M1418C6



M18 5.0Ah REDLITHIUM-ION Battery
M18B56



18V 12.0Ah Li-ion Battery
M18HB12



18V Li-Ion Worksite Radio Charger
M18RC-0



18V Charger & Battery 1.3Ah
RBC18L13C



12v Smart Start Charger
SJS1200



6/12VDC 4A 8-Step Bluetooth
MB3906



Charger For PG450 3ah
PGC-3A

WWW.MRFILTER.COM.AU



CTEK Battery Charger 12V
PRO15S



1 Amp Power Supply Charger
PS002



UMC12V Autec Battery
UMC12V



12V 2A Jump Starter Charger
MAC02



Battery Charger & Cranking Tester
SP61063



Charger Battery 8 Stage 3.5A
SP61075



Charger 15amp 8 Stage 6, 12, 24v
SP61084



Multivolt Smart Battery
SP61086



Battery Charger Suit SP81982
SP81893



Battery Charger 18V 3.0Ah
SP81989



Battery Charger 12V 10A
SPI10



Battery Charger 12V/15A
SPI1224



Battery Charger 12V 6A
SPI6



Digital Charging Scale 100KG
TO9006



Battery Charger 6/12V 4 Amp
TWNEVADA11



Battery Charger, 230V 12/24V
TWSPRINTER6000



12V - 18V Multi Voltage Battery Charger
W114751



18V Charger M12-18Ac Charger
W124234



18V 5.0Ah Li-ion Batteries & Charger
W192020



12V 6.0Ah Li-ion RED LITHIUM Battery
W121899

WWW.MRFILTER.COM.AU

SYDNEY (02) 9769 1166

Mr Filter EST 1996
TRUCKING EARTHMOVING MINING
SUPPLIES

BRISBANE (07) 5540 7530



3.0Ah Li-ion RED LITHIUM Battery
W121900



18V Li-Ion 6 Bay Battery
W199279



18V Li-ion 6 Bay Battery Charger
W201587



12V 2.5Ah Battery & Charger
W208831



12V Red Lithium Battery Charger
W73467



28V Battery Charger
W80807



Battery Charger 40A
RBC400



Battery Charger
SSC01BC

Batteries, Jump Starters & Chargers - Jump Starters & Leads



Jumper Lead HD 500Amps X 4Mtr
035104



Jumper Leads With Anti Static X 4Mtr
035104A



Mechpro Blue Jumper Cables
MPBCBL200S2



Red Clamp Porta Power
1201



Jumper Cable 400Amp X 3.5Mtrs
RG2003



Jumper Cable 600 Amp X 3.5 Mt
RG2002



SJS Jump Starter 1500A
SJS1500



SJS 3000 Amp Smart Jump Start
SJS3000



Jumper Leads HD 6mtr
RG2019



Dominator 2 Jump Starter
DOM2



Lithium-Ion Jump Start 1,000Amp
GB40



Lithium-Ion Jump Start 20,000Amp
GB500

WWW.MRFILTER.COM.AU



Hi-Tec Mini Battery Jump Starter
HB15-MJS-V7



Lithium-Cobalt Jump Starter
HU6510



Lithium-Cobalt Jump Starter
HU6511



Hypastart Supercapacitor Jump Starter
HYPA-X2500



12/24V 2000A Jump Starter and Power
IS2000



12/24V Surge Protector Service Minder
MA20121224



Matson 12/ 24V HD Jump Starter
MA3400



12/24V Lithium Jump Starter
MA35000



Jump Starter/Power Pack 2000A
SL1452



Power Supply Portable Jump Starter
SP61070



Jump Starter Lithium+ Power Bank
SP61071



Jump Starter Li+ Cobalt
SP61073



Ultra Capacitor Jump Starter 700A
SP61074



Ultra Power 4300A Jump Starter
SP61097



Roadside Assist Jump Pack
RA3800



Jump Start Plug Assembly
9S-3664



Uniden Waterproof Jump Start Kit
UPP1000



2000 Peak Amp Lithium Ion Jump Starter
W170233



Booster Pack 12/24 22.2ah
26096



Power Adaptor 56 Watt
XGC4

WWW.MRFILTER.COM.AU

SYDNEY (02) 9769 1166

Mr Filter
EST 1996
TRUCKING EARTHMOVING MINING
SUPPLIES

BRISBANE (07) 5540 7530



12/24V Truck Start 2 - 6200/3100 Amps
P1224



SOS Booster Schumacher
PBI2015



12/24 Volt Thunderbolt Jump Starter
MA8000

Beacons, Torches & Worklights - Beacon Lights



Amber 3 Module Led Emergency
120033AM



Amber 4 Module Led Emergency
120034AM



Amber 6 Module Led Emergency
120035AM



White 6 Module Led Emergency
120035WM



Legion Light Bar LED 24V
85032A-24



Micro Bar Clear Lens with Amber LED
IL-011C



Clear Lens Micro Bar Amber LED
IL-011C-M



111 LED Beacon Magnetic Amber
111010



103 LED Beacon 3 Bolt - Amber
103000



103 LED Beacon 3 Bolt Green
103300C



Amber Revolving Lamp 12V
1702



Halogen Beacon Amber 24V
1705



Klaxon Flashguard QBS Amber
309-5887



Klaxon Flashguard QBS Amber
309-6032



Amber Beacon 12/24V 3 Bolt Mount Fix
320-00



Amber Beacon 12/24V Pole Mount
322-00

WWW.MRFILTER.COM.AU



Amber Rotating Beacon
35-205-000-01



Revolving Amber Light
37280



Amber Led Mini Lightbar 10-100V
493-00



12/24 Volt Aeromax Mini LED Light
85010A



LED Dash Light 12/24V Amber
85293A



Sentry LED Battery Powered Strobe
85320A



Led Beacon Amber Magnetic Mount
85324A



Strobe Light (Amber) Flange 12-80V
85338A



12-80V LED Quad Flash Strobe Light
85346A



LED Strobe Amber 12-80V
85374A



'Euro Flex' Rotating Beacon (Amber)
85402A



Aeromax Amber Rotating Beacon
85470A



LED Light Bar Amber Magnetic Mount
RBL74



LED Light Bar Amber Fixed Mount
RBLF74



Halogen Beacon/Strobe Amber 12/24V
85654A



Optimax Rotating Beacon (Amber)
85660A



12/24V Amber LED Optimax Beacon
85664A



Amber Led Emergency Lamp 12/24V
90AM



Hella Blue Lens To Suit 1722MAG
9171701



Green 3 Module Led Emergency Lamp
93GM

WWW.MRFILTER.COM.AU

SYDNEY (02) 9769 1166

Mr Filter EST 1996
TRUCKING EARTHMOVING MINING
SUPPLIES

BRISBANE (07) 5540 7530



LED Strobe Red 9 to 33V
98091044



Halogen Beacon Amber
ACX2123



Lens To Suit ACX2188, ACX2123, ACX2128
ACX2124



Ecco Halogen Beacon Amber 12/24V
ACX2136



GREEN LENS SUIT ACX2136
ACX2142



Halogen Beacon Amber 12/24V Pole
ACX2143



OEX Beacon Bracket Universal
ACX2187



OEX Slimline Amber LED Beacon
ACX2367



Slimline Amber LED Beacon
ACX2368



OEX Slimline Amber LED Beacon
ACX2369



OEX Tall Amber LED Beacon
ACX5725



Led Amber Rotating Beacon
LS9784



Crossfire LED Beacon Fixed
B86S



Magnetic Beacon Light - Solar
BEACONYEL



Led Beacon Amber 10-30V
BF304-00



Strobe Module LED 10-30V
LE4PA



Lighting Emergency LED Red
OS-KRLED03B-R



LED Strobe Amber 12/30V
HM500ADIR



K-LED Mining Amber LED Beacon
HM9600ADIR



Amber LED Beacon 12/24v
HU9782

WWW.MRFILTER.COM.AU



Revolving / Strobe Light
MT10701



Led Amber Rotating Beacon
LRB130



Super Slim LED Beacon
B45S



Amber Led Cone Beacon 4X Flash
LS9935



LED Beacon 98 Series 10-110V
RB98Y



LED Amber/Green Beacon
LS9964



Led Amber Strobe Beacon
LS9975



Led Amber Strobe Beacon
LS9976



LED Beacon Micro Revolver
RB112PY



LED Pole Mount Beacon
RB155PY



LED Beacon Micro Magnetic
RB112MY



LED Beacon Micro Fixed Mount
RB112Y



LED Beacon Amber 12 or
V11050



LED Beacon RB130 Series 10 - 36V
RB130MYR



LED Beacon RB130 Series
RB130YR



LED Beacon Revolver Mini
RB132MY



LED Beacon Revolver
RB155MY



LED Beacon Revolver Magnetic
RB167MY



LED Beacon Revolver Fixed Mount-
RB167Y



Ecco Magnetic Led Warning
ED0016A

WWW.MRFILTER.COM.AU

SYDNEY (02) 9769 1166

Mr Filter EST 1996
TRUCKING EARTHMOVING MINING
SUPPLIES

BRISBANE (07) 5540 7530



1860Mm 12V Beacon Bar Amber
IL600A11AA



Active



Inactive

Bolt On Amber Mini Light Bar
LB246ACM



Active



Inactive

Magnetic Amber Mini Light Bar
LB246ACMM



Active



Inactive

Bolt On Amber Light Bar
LB380ACM



Replacement Lens Green
RL165G



Replacement Lens Red
RL165R



Replacement Lens White
RL167W



LED Rechargeable Magnetic Mini
RRB71



LED Strobe Module Amber
RSM5104A



LED Forklift Light Blue
RVFBS6



Drive Belt Suits Rotating Beacon
15244-00



LED Beacon Quad Strobe Amber
RB39VYR



Bracket Suit Rotat & Strobe Beacons
LS9948



LED Flashing Traffic Baton
BATLED50



Warning Lamp
611503

Beacons, Torches & Worklights - Electronic Signs



Led Message Display M5 Matrix
CD0012R



Sequential Traffic Director
S30000

Beacons, Torches & Worklights - Torches



240V Fluorescent Inspection Light
71200



Rechargeable LED Inspection Light
71312



Narva Led Inspection Lamp
71320



High Powered L.E.D Inspection Light
71330



500 Lumen Folding LED Work Light
71462



Torch With Magnets
GRAB-AND-GO



Cordless 12V Mini Flashlight
SP81412BU



Cordless 18V Flashlight Led
SP81424BU



Pen Light /Torch Rechargeable
SP81439



LED Pen Torch
SP81443



Torch/Work Light - Smd Led
SP81456



Led Wireless Charge Hand Held
SP81496

WWW.MRFILTER.COM.AU

SYDNEY (02) 9769 1166

Mr Filter EST 1996
TRUCKING EARTHMOVING MINING
SUPPLIES

BRISBANE (07) 5540 7530



18V Li-ion Rotating LED Stick
W109295



Adventurer Torch
ZLAD



CT5 Series LED Signal Tower
AU-CT5-Q31



PC7 Series LED Signaltower
AU-PC7-Q01



Led Torch Stedi FX4800
FX4800



80 Lumen Mini Torch
SBQ1MINI



800Lm Rechargeable Torch
SBQ4XR



Flashlight - Adjustable Led
SP81490



Led Cordless Workshop Light
20066N2



Cordless LED Cap Lamp
TJL06L



UV Led Flashlight
TOX226



Led Torch Waterproof Rubber
TC03



18V Li-Ion LED Search Light
W121943



Dolphin Torch
S60000



Sensor & Dimmable Headlight
SENSORHEADLIGHT



Ansmann LED Head Torch
195-0335



Arlec 300 Lumen LED Head Torch
4410939



COB LED Headlamp Motion
SP81492



250 Lumen Head Lamp
71426



450 Lumen Headlamp
IRHL450

WWW.MRFILTER.COM.AU

SYDNEY (02) 9769 1166

Mr Filter EST 1998
TRUCKING EARTHMOVING MINING
SUPPLIES

BRISBANE (07) 5540 7530



Handy Mobile COB Head-
ZLHL



Dual Slimline Headlamp
SP81459



Slimline Led Headlamp
SP81491



120 Lumen LED Head Lamp
71424



Led Lenser H7R Core 1000
ZL502122



Underground cordless Cap Lamp
KH4E-EX



Cordless Cap Lamp
RN3U



Cordless Cap Lamp 10AH
KL10M



MCK Corded Cap Lamp
MKC



2-In-1 Flex-Light-Magnet
8871



Flashlight Flexible
SP31601



Flex Torch Magnetic
PT41300



PC7 Series Multi-Tone Module
AU-PC7ZI



LED CAMPING Lamp
HU9693



Panel Torch Led Zip
ZLPL



Pro Torch Extend
ZLPT

Beacons, Torches & Worklights - Worklights



20W LED Security Floodlight
0184013



2 x 20W 3200lm LED Worklight
0206011



18V Li-Ion LED Remote Stand
129469



Arlec 1000W Halogen
7070522

WWW.MRFILTER.COM.AU

SYDNEY (02) 9769 1166

Mr Filter EST 1996
TRUCKING EARTHMOVING MINING
SUPPLIES

BRISBANE (07) 5540 7530



LED Mini Senator Work Light
72469



9-36V Led Work Lamp 20W
72360



9-64V LED Work Lamp Flood
72449



Round Work Lamp 12V 35W
72450



Narva 9-33V LED Lamp
72474



LED Spot Light 9 To 33V
72706



Led Round Worklamp Flood
7512BM



48 watt LED work light
DDL48S



Led Square Worklamp
FL1



Led Round Worklamp
FL2



Hulk 4x4 LED Worklamp
HU9670



Led Rectangular Worklamp
HU9672



Led Square Worklamp Flood
HU9675



Led Square Worklamp
IWL2401F



4" Round LED Worklamp
IWL3601RF



4" Square LED Worklamp
IWL3601SF



160 LED Square Work Lamp
LEDWL160



163 LED Round Work Lamp
LEDWL163



Work Light Round 5 Led
LLX08201



Led Worklamp Ultra Flood
ROK40UF

WWW.MRFILTER.COM.AU

SYDNEY (02) 9769 1166

Mr Filter EST 1998
TRUCKING EARTHMOVING MINING
SUPPLIES

BRISBANE (07) 5540 7530



LED Work Light Square 16x6W
RWL4196F



LED Work Light Round 10-30V
RWL427RF



LED Work Light Square 10-30V
RWL427SF



LED Work Light Square H/Duty
RWL5246F



Thunder 9 LED Square Work Light
TDR08205



Work Light Square 10-30V
RWL530F



LED Work Light Round 10-30V
RWL636FHS



LED Work Light Square Flood
RWL814FHS



LED Work Light Round Flood
RWL814RF



LED Work Light Square Flood
RWL814SF



LED Work Light Round Flood
RWL9424RF



LED Work Light Square 2200lm
RWL9424SF



LED Work Light Square 958lm
RWL9510SF



Led Square Worklamp
WL0601



Led Round Worklamp
WL0701



Led Rectangle Worklamp Flood 6.6 Watt
WL0732



Led Rectangle Worklamp Flood 18Watt
WL0814



10 Watt Led Work Light Rugged
YL606-10W



12 Watt Led Work Light Rugged
YL605-12W



12 Watt Led Work Light Rugged
YL602-12W

WWW.MRFILTER.COM.AU

SYDNEY (02) 9769 1166

Mr Filter EST 1998
TRUCKING EARTHMOVING MINING
SUPPLIES

BRISBANE (07) 5540 7530



18 Watt Led Work Light Rugged
YL602-18W



18 Watt Led Work Light Rugged
YL613-18W



Portable Led Magnetic Light
yl608-15w



Led Rectangular Flood
RWL118F



LED Work Light Rect Spot
RWL118S



Exelite Led Worklight & Torch
LED6-5WKL



LED Work Light Slimline
SP81446



Led Wireless Charge Worklight
SP81499



USB Pivoting Work Light
W141515



Ledlenser ZL502184 170 Lumens
W177124



LED Inspection Light 12V -
LLX2999



4 + 1 Led Worklight & Torch
LED4-1WKL



Big Slim Worklight & Torch
BIGSLIM



1 Watt Led Worklight
5089TQ



Ledlenser ZL502083 (iW2R)
ZL502083



Premium Under Bonnet LED Worklight
SP81466



18V Li-Ion LED Area Light - Skin
W103362



18V Li-ion Jobsite Light Flood
W134060



Handle To Suit Led Worklamps
WL0613

WWW.MRFILTER.COM.AU

SYDNEY (02) 9769 1166

Mr Filter EST 1998
TRUCKING EARTHMOVING MINING SUPPLIES

BRISBANE (07) 5540 7530

Cable, Wire & Tubing - Extension Cords



240V Electric Cable Reel
CR30060



20M Retractable Electrical Cord
GDT200b

Cable, Wire & Tubing - Extension Leads & Power Boards



10m White Extension Lead
0189126



Lead Extension Click 25MT
0189131



40m 2.5mm 15A HD Extension Lead
0191739



Welders Extension Lead 15amp
21376



Welders Extension Lead 15AMP
21386



20m 15A Caravan Extension Cable
4430369



10M Extension Cord 10Amp
76772



10Amp Extension Cord 5M
76789



10Amp Extension Lead 3M
76796



Contractor Hd 30M Extension Lead
UR2025C



Contractor Hd Extension Lead
UR25025C



32A 10m 240V Hd Industrial Extension
XLH6A6AR3P32106



4 Way Power Board
76802



Power Board - 4 Outlet - 4 USB
SP69998



Power Board Sp 4 Outlet
SP69999



Lead Extension Delta 25M
4420470

WWW.MRFILTER.COM.AU

SYDNEY (02) 9769 1166

Mr Filter EST 1999
TRUCKING EARTHMOVING MINING SUPPLIES

BRISBANE (07) 5540 7530



5-Pack Extension Lead Hooks
BEH765-5

Cable, Wire & Tubing - Heat Shrink Tube

SKU	Description
ACX1269	OEX Heat Shrink Standard Red ID: 3.2mm Length: 10m
ACX1270	OEX Heat Shrink Standard Black ID: 3.2mm Length: 10m
ACX1274	OEX Heat Shrink Standard Black ID: 4.5mm Length: 10m
ACX1275	OEX Heat Shrink Standard Red ID: 6.4mm Length: 10m
ACX1280	OEX Heat Shrink Standard Red ID: 12mm Length: 10m
ACX1282	OEX Heat Shrink Standard Black ID: 12mm Length: 10m
ACX1283	OEX Heat Shrink Standard Red ID: 18.2mm Length: 1.2m
ACX1284	OEX Heat Shrink Standard Red ID: 18.2mm Length: 10m
ACX1285	OEX Heat Shrink Standard Black ID: 18.2mm Length: 1.2m
ACX1286	OEX Heat Shrink Standard Black ID: 18.2mm Length: 10m
ACX1287	OEX Heat Shrink Standard Red ID: 25.4mm Length: 10m
ACX1288	OEX Heat Shrink Standard Red ID: 25.4mm Length: 10m
ACX1296L	OEX 24mm Dual Wall Heat Shrink Polyolefin with Adhesive Tubing Black 1.2M
ACX1297L	OEX 39mm Dual Wall Heat Shrink Polyolefin with Adhesive Tubing Black 1.2M



WWW.MRFILTER.COM.AU

Mr Filter EST 1998
TRUCKING EARTHMOVING MINING
SUPPLIES

SYDNEY (02) 9769 1166

BRISBANE (07) 5540 7530



SKU	Description
56614-10	Narva Heat Shrink Standard Black ID: 4.8mm Length: 10m
56616-10	Narva Heat Shrink Standard Black ID: 6.4mm Length: 10m
56618-10	Narva Heat Shrink Standard Black ID: 9.5mm, Length: 10m
56620-5	Narva Heat Shrink Standard Black ID: 12.7mm Length: 5m
56612-20	Narva Heat Shrink Standard Black ID: 3.2mm Length: 20m



Heatshrink Tubing Assortment 9.5 - 19Mm

56602



Heatshrink Tubing Assortment 3.2 - 6.4Mm

56600



Cable Joiner Red Cable 2.5 - 3mm 50 Pce

56350



120 Pc 5-Colour Heat Shrink Tubing

43110



127 Pc Heat Shrink Tubing Assortment

43113



216p Heatshrink Tubing Assortment

56604



Dual Wall Heat shrink Tubing Assortment

56654



Grab Kit Heat Shrink

RG2886



Raptor 80 pieces Pack Mixed
HSCP-80



75Pc Heat Shrink Tube
RG28148



Heat Shrink Tube Kit 136Pc
RG28151



Heat Shrink Tube Kit 65Pce
SP32293

WWW.MRFILTER.COM.AU

SYDNEY (02) 9769 1166

Mr Filter
EST 1998
TRUCKING EARTHMOVING MINING
SUPPLIES

BRISBANE (07) 5540 7530



12Mm Red Dual Wall Adhesive
56690



3.2Mm Black Heatshrink (1.2M)
56612BL



Heat Shrink Standard Black 12.7mm
56620



19Mm Red Heatshrink (1.2M)
56642



19Mm Red Heatshrink Tubing (5M)
56642-5



3Mm Black Dual Wall Adhesive
56662



19Mm Black Heatshrink (1.2M)
56622



12Mm Black Dual Wall Adhesive
56670



18Mm Black Dual Wall Adhesive
56672



24Mm Black Dual Wall Adhesive
56674



24Mm Red Dual Wall Adhesive
56694



24.5Mm Black Heatshrink (1.2M)
56624



5/2.5mm Heat Shrink Tubing Black
HS0005B



7/3.5mm Heat Shrink Tubing Black
HS0007B



Heat Shrink Tubing 5M Black 13.0Mm
HS0013B-5

Cable, Wire & Tubing - Tubing



Spiral Wrap 10-13Mm Id
20110



Spiral Wrap 15-18Mm Id
20115



Spiral Wrap 19-22Mm Id
20124



Spiral Wrap 63MM Per Mt
SGX-N63



6Mm x 10m Spiral Wrap
56700



Spiral Wrap 12mm x 10m
56702



HD Spiral Wrap 38mm - 20m
ACX1455



Split Tubing 21.1mmx10m
ACX1112

SKU	Description
56708	Narva Convoluted Split Tubing ID:7mm Length 30m
56711	Narva Convoluted Split Tubing ID: 10mm Length 30m
56714	Narva Corrugated Split Tubing 13mm x 30m
56715	Narva Convoluted Split Tubing ID:13mm - Length 75m
56721	Narva Convoluted Split Tubing ID:20mm - Length 30m
56750-50	Narva Convoluted Tubing ID:6.4mm - Length 50m
56751-50	Narva Convoluted Tubing ID:9.9mm - Length 50m



WWW.MRFILTER.COM.AU

SYDNEY (02) 9769 1166

Mr Filter
EST 1999
TRUCKING EARTHMOVING MINING SUPPLIES

BRISBANE (07) 5540 7530



SKU	Description
CR7-3	Split Tube - Black 7mm X 3.3mtr
CR11-3	Split Tube - Black 11mm X 3.3mtr
CR13-10	Split Tube - 10Pc Black 13mm X 10mtr
CR15-3	Split Tube - Black 15mm X 3.3mtr
CR7-10	Split Tube - Black 7mm X 10mtr

SKU	Description
PT0450	PVC TUBING 4mm ID 50m ROLL BLACK TUBING
PT0710	SPLIT TUBING 7.0mm I.D 10m CONVOLUTED TUBING
PT0730	SPLIT TUBING 7.0mm I.D 30m CONVOLUTED TUBING
PT0750	SPLIT TUBING 7.0mm I.D 50m CONVOLUTED TUBING
PT1010	SPLIT TUBING 9.7mm I.D 10m CONVOLUTED TUBING
PT1030	SPLIT TUBING 9.7mm I.D 30m CONVOLUTED TUBING
PT1310	SPLIT TUBING 12.8mm I.D 10m CONVOLUTED TUBING
PT1330	SPLIT TUBING 12.8mm I.D 30m CONVOLUTED TUBING
PT1610	SPLIT TUBING 16.3mm I.D 10m CONVOLUTED TUBING
PT1630	SPLIT TUBING 16.3mm I.D 30m CONVOLUTED TUBING
PT2010	SPLIT TUBING 21.5mm I.D 10m CONVOLUTED TUBING
PT3010	SPLIT TUBING 29mm I.D 10m CONVOLUTED TUBING



WWW.MRFILTER.COM.AU

Cable, Wire & Tubing - Wire & Accessories

SKU	Description
58127BK	5A 2.5MM BLACK SINGLE CORE CABLE (7M)
58127GN	5A 2.5MM GREEN SINGLE CORE CABLE (7M)
58127RD	5A 2.5MM RED SINGLE CORE CABLE (7M)
58137BE	10A 3MM BLUE SINGLE CORE CABLE (7M)
58137BK	10A 3MM BLACK SINGLE CORE CABLE (7M)
58137BN	10A 3MM BROWN SINGLE CORE CABLE (7M)
58137GN	10A 3MM GREEN SINGLE CORE CABLE (7M)
58137RD	10A 3MM RED SINGLE CORE CABLE (7M)
58137WE	10A 3MM WHITE SINGLE CORE CABLE (7M)
58137YW	10A 3MM YELLOW SINGLE CORE CABLE (7M)
58144BN	CABLE SINGLE CORE 4MM 15A 4M BROWN
5814-30WE	15A 4MM WHITE SINGLE CORE CABLE (30M)
58144BE	CABLE SINGLE CORE 4MM 15A 4M BLUE
58144BK	CABLE SINGLE CORE 4MM 15A 4M BLACK
58144GN	CABLE SINGLE CORE 4MM 15A 4M GREEN
58144RD	CABLE SINGLE CORE 4MM 15A 4M RED
58144WE	CABLE SINGLE CORE 4MM 15A 4M WHITE
58144YW	CABLE SINGLE CORE 4MM 15A 4M YELLOW
58227SP	2.5A 2MM TWIN CORE SPEAKER CABLE (7M)



OEX

SKU	Description
ACX0556	OEX 2mm Single Core Automotive Cable, Black - 50m Roll
ACX0558	OEX 2mm Single Core Automotive Cable, Red - 50m Roll
ACX0761	OEX 6mm Single Core Automotive Cable, Black - 30m Roll
ACX0763	OEX 6mm Single Core Automotive Cable, Red - 30m Roll
ACX0800	OEX 2mm Twin Core Speaker Cable, Figure 8, Grey With Black Trace - 30m Roll
ACX0806	OEX 3mm Twin Core Automotive Cable, Red/Black, With Black Sheath - 30m Roll
ACX0806L	OEX 3mm Twin Core Automotive Cable, Red/Black, With Black Sheath - 100m Roll
ACX0812	OEX 3mm 3 Core Automotive Cable, Brown/White/Yellow With Black Sheath - 30m Roll
ACX0813	OEX 3mm 5 Core Trailer Cable, With Black Sheath - 30m Roll
ACX0816	OEX 3mm 7 Core Trailer Cable, With Black Sheath - 30m Roll
ACX0816L	OEX 3mm 7 Core Trailer Cable, With Black Sheath - 100m Roll
ACX0820	OEX 2.5mm 5 Core Trailer Cable, With Black Sheath - 30m Roll
ACX0902	OEX 6 B&S Single Core Battery Cable, Black - 30m Roll
ACX0903	OEX 6 B&S Single Core Battery Cable, Red - 30m Roll
ACX0906	OEX 3 B&S Single Core Battery Cable, Black - 30m Roll
ACX0907	OEX 3 B&S Single Core Battery Cable, Red - 30m Roll
ACX0927	OEX 8 B&S Twin Core Battery Cable, Red/Black With Black Sheath - 30m Roll
ACX0927-5BL	OEX 8 B&S Twin Core Battery Cable, Red / Black With Black Sheath - 5m Blister Pack

WWW.MRFILTER.COM.AU

SKU	Description		
CW1301	3mm SINGLE CORE CABLE BLACK 30m (14/0.32) (AUTO 150)	CW3251	2.5mm FIVE CORE TRAILER CABLE W/ BLACK SHEATH 30m (8/0.32)
CW1305	3mm SINGLE CORE CABLE RED 30m (14/0.32) (AUTO 150)	CW3271	2.5mm SEVEN CORE TRAILER CABLE W/ BLACK SHEATH 30m (8/0.32)
CW1401	4mm SINGLE CORE CABLE BLACK 30m (23/0.32) (AUTO 152)	CW3331	3mm THREE CORE CABLE WHITE YELL BROWN W/ BLACK SHEATH 30m
CW1403	4mm SINGLE CORE CABLE GREEN 30m (23/0.32) (AUTO 152)	CW3351-PM	3mm FIVE CORE TRAILER CABLE W/ BLACK SHEATH 1m
CW1407	4mm SINGLE CORE CABLE WHITE 30m (23/0.32) (AUTO 152)	CW3371	3mm SEVEN CORE TRAILER CABLE W/ BLACK SHEATH 30m (14/0.32)
CW1409	4mm SINGLE CORE CABLE BLUE 30m (23/0.32) (AUTO 152)	CW3371-PM	3mm SEVEN CORE TRAILER CABLE W/ BLACK SHEATH 1m
CW1411	4mm SINGLE CORE CABLE BROWN 30m (23/0.32) (AUTO 152)	CW3372	3mm SEVEN CORE TRAILER CABLE W/ BLACK SHEATH 100m (14/0.32)
CW1413	4mm SINGLE CORE CABLE YELLOW 30m (23/0.32) (AUTO 152)	CW3452	4mm FIVE CORE TRAILER CABLE W/ BLACK SHEATH 100m (23/0.32)
CW1415	4mm SINGLE CORE CABLE ORANGE 30m (23/0.32) (AUTO 152)	CW3471	4mm SEVEN CORE TRAILER CABLE W/ BLACK SHEATH 30m (23/0.32)
CW1417	4mm SINGLE CORE CABLE PINK 30m (23/0.32) (AUTO 152)	CW7301	3mm SINGLE CORE GAS CABLE RED W/ BLACK SHEATH 30m (14/0.32)
CW1419	4mm SINGLE CORE CABLE GREY 30m (23/0.32) (AUTO 152)	CW7401	4mm SINGLE CORE GAS CABLE RED W/ BLACK SHEATH 30m (23/0.32)
CW1421	4mm SINGLE CORE CABLE VIOLET 30m (23/0.32) (AUTO 152)	CW8001	0 B&S BATTERY CABLE BLACK 30m 49.00mm ² (608/0.32) 246amps
CW1507	5mm SINGLE CORE CABLE WHITE 30m (36/0.32) (AUTO 154)	CW8002	0 B&S BATTERY CABLE RED 30m 49.00mm ² (608/0.32) 246amps
CW1501	5mm SINGLE CORE CABLE BLACK 30m (36/0.32) (AUTO 154)	CW8201	2 B&S BATTERY CABLE BLACK 30m 32.07mm ² (399/0.32) 188amps
CW1601	6mm SINGLE CORE CABLE BLACK 30m (57/0.32) (AUTO 156)	CW8202	2 B&S BATTERY CABLE RED 30m 32.07mm ² (399/0.32) 188amps
CW2201	2mm TWIN CORE CABLE RED BLACK W/ BLACK SHEATH 30m (7/0.32)	CW8301	3 B&S BATTERY CABLE BLACK 30m 26.45mm ² (329/0.32) 168amps
CW2301	3mm TWIN CORE CABLE RED BLACK W/ BLACK SHEATH 30m (14/0.32)	CW8302	3 B&S BATTERY CABLE RED 30m 26.45mm ² (329/0.32) 168amps
CW2302	3mm TWIN CORE CABLE RED BLACK W/ BLACK SHEATH 100m (14/0.32)	CW8600	6 B&S BATTERY CABLE BLACK 100m 13.50mm ² (168/0.32) 103amps
CW2401	4mm TWIN CORE CABLE RED BLACK W/ BLACK SHEATH 30m (23/0.32)	CW8601	6 B&S BATTERY CABLE BLACK 30m 13.50mm ² (168/0.32) 103amps
CW2402	4mm TWIN CORE CABLE RED BLACK W/ BLACK SHEATH 100m (23/0.32)	CW8602	6 B&S BATTERY CABLE RED 30m 13.50mm ² (168/0.32) 103amps
CW2501	5mm TWIN CORE CABLE RED BLACK W/ BLACK SHEATH 30m (37/0.32)	CW8801	8 B&S BATTERY CABLE BLACK 30m 7.71mm ² (96/0.32) 74amps
CW2601	6mm TWIN CORE CABLE RED BLACK W/ BLACK SHEATH 30m (57/0.32)	CW8802	8 B&S BATTERY CABLE RED 30m 7.71mm ² (96/0.32) 74amps
CW2602	6mm TWIN CORE CABLE RED BLACK W/ BLACK SHEATH 100m (57/0.32)	CW3351	3mm FIVE CORE TRAILER CABLE W/ BLACK SHEATH 30m (14/0.32)



WWW.MRFILTER.COM.AU

Mr Filter EST 1998
TRUCKING EARTHMOVING MINING SUPPLIES

SYDNEY (02) 9769 1166

BRISBANE (07) 5540 7530



5 Outlet Electrical Enclosure Box
0065728



Metri-Pack Cable Seal 100pack
15324976



Extension Cable - Universal - 3 ft
37108



Plug and Lead 3 Wire
53102



255A Black 2 B&S Cable
580230BK



255A Red 2 B&S Cable
580230RD



5A 2.5Mm Black Single Core
581230BK



5A 2.5Mm Red Single Core
581230RD



4Mm Single Core Cable Red/Black (100M)
5814-100DI



15A Black 4Mm Marine Cable (30M)
5814M-30BK



15A Red 4Mm Marine Cable (30M)
5814M-30RD



Cable Twin Sheath 10A 3mmx100m
5823100BW



10A 3Mm Twin Core Fig 8 Cable (4M)
58234F8



10A 3Mm 3 Core 30M
5833-30WYB



4 Core Electric Brake Control Cable
5846-30BK



5 Core 3mm Trailer Cable 30M
5853-30TC



Battery Cable To Starter B&S 25Cm
BC10-2B



Battery Cable To Starter 380mm
BC15-00



Battery Cable B/B 12 Inch 30Cm
BL1312B



Battery Cable 8 200Mm Black
BL1008B

WWW.MRFILTER.COM.AU

SYDNEY (02) 9769 1166

Mr Filter
EST 1998
TRUCKING EARTHMOVING MINING
SUPPLIES

BRISBANE (07) 5540 7530



Starter Cable B/S 18 Inch 45Cm
BL1018B



Cable B/S 24 Inch 60Cm
BL1024B



Cable B/S 36 Inch 90Cm
BL1036B



Battery Cable B/B 10 Inch
BL1310B



Battery Cable B/S 12 Inch 30Cm
BL1012B



Packet 10 Black Steel Chassis Clip
NC9621



Battery Joiner Cable 15cm
TEJ15



Battery Joiner Cable 20cm
TEJ20



Battery Joiner Cable 23cm
TEJ23



Battery Joiner Cable 25cm
TEJ25



Battery Joiner Cable 30cm
TEJ30



Battery Joiner Cable 38cm
TEJ38



3mm 5 Core Trailer Cable - Black 30m
C109-30BLK



4mm Twin Sheath Cable - Red/Black 30m
C50-30BLK



Battery Cable 2 B&S - Black 30m 8mm
C8-30BLK



Battery Cable 2 B&S - Red 30m 8mm
C8-30RED



Trailer Cable 5 Core 3mm Black 30m
CB003A5-030



Cable 4Mm Single Core 30M Violet
CB004A1-030VT



Tycab Wire Single Blue 30Mtr 2.5Mm
CB02SA1030BE



Tycab Wire Single Black 30Mtr 2.5Mm
CB02SA1030BK

WWW.MRFILTER.COM.AU



Wire Single Green/White 30Mtr 2.5Mm
CB02SA1030GNWE



Wire Single Orange 30Mtr 2.5Mm
CB02SA1030OE



Wire Single Red 30Mtr 2.5Mm
CB02SA1030RD



Battery Cable #2 Black P/M
CB102A1-030BK



Battery Cable #2 Red P/M
CB102A1-030RD



6B&S battery cable 30M
CB106A1030BK



Battery Cable 0B&S Black 30M
CB110A1-030BK



3Mm Single Core Cable Black 7M
CW0301



3mm Single Core Cable Red 7M
CW0305



3Mm Single Core Cable Blue 7M
CW0309



3Mm Figure 8 Red / Black 4M
CW0802



Dc Power Lead Wiring For Tx3600
LE09



B25E 25m 10A 4 Socket HD Cable Reel
W125683



Cable Protector - 1 Channel Drop Over 1M
CP01



Cable Protector 2 Channel
CABPRO2PU



Cable Looped Masterlock
0071649427503

Cameras, Sensors & Trackers - Cameras, Monitors & Accessories



Samsung Evo Plus 128GB
532583



Wireless Security Camera
APPCAM-SOLO-4



15m Extension Lead 4 Pin
AX15M-4P



20M Camera Extension Cable
AX20M-4B

WWW.MRFILTER.COM.AU

SYDNEY (02) 9769 1166

Mr Filter
EST 1998
TRUCKING EARTHMOVING MINING
SUPPLIES

BRISBANE (07) 5540 7530



Female Double Connection
AX4F-F



Male to Male 4 Pin Adapter Cable
AX4M-M



4-Pin (M) Adaptor Cable To RCA (F)
AX4P-M-RCA-F



4-Pin (M) Adaptor Cable To RCA (M)
AX4P-M-RCA-M



6M Camera Extension Cable
AX6M-4P



Mp3 Cd Receiver With Front Panel
AX901



CCD Reverse Camera Charcoal
ECC80



Monitor 7 inch 1080 3ch
BHD-M701



Monitor Stand Bracket
BKT100



On-glass HD Bracket (Suction)
BKT101



Reversing Camera
BR-C01



5" CCTV Kit BHDCK5000
BR-CK5001



7" CCTV Kit BHDCK7000
BR-CK7001



Mini Rear Camera
BRCM04



Axis Heavy Duty Dome
C30



AXIS Multi-Fit Camera IP69
C40



2.4G Wireless Rear Camera
CC007W



HD Compact CCD 1/3" Camera
CC05



HD CCD Camera
CC08



Wideangle CCD Camera
CC20

WWW.MRFILTER.COM.AU



CCD Camera With Auto Shutter
CC70M



HD Weatherproof Rear View
CHD10



4 Channel DVR Black Box
DV426-4G



OEM Style Full HD DVR - Wifi
DVR3



Autobacs Compact Rearview
FHD05



1080P Reverse Camera
FHD20



Full HD Heavy Duty Sideview
FHD410



Full HD Rearview Camera
FHD639



Gator Wireless Rear View
GT700W2



7" Wireless Camera Kit
HD074WK



Axis 7 inch Heavy Duty
HD264



5" Heavy Duty Led Monitor
JS5001



7" High Resolution Monitor Fuji
HD7130



7" High Resolution Reversing Kit
HD7130K



7" Touchscreen Quad View
HDT74



Black Bundle Camera Action
HERO10



10 Meter Camera Cable
HDC10M-4P



15 metre 4 Pin AHD Camera
HDC15M-4P



20 metre 4 Pin AHD Camera
HDC20M-4P



3 metre 4 Pin AHD Camera
HDC3M-4P

WWW.MRFILTER.COM.AU

SYDNEY (02) 9769 1166

Mr Filter EST 1998
TRUCKING EARTHMOVING MINING
SUPPLIES

BRISBANE (07) 5540 7530



6 metre 4 Pin AHD Camera
HDC6M-4P



Reverse Camera Kit Wireless 5.6"
JS056WK



6.86" Rearview DVR Mirror
DVR1905K



4.3" Clip On Monitor/Rear View
JS043K



7" Recording Wireless Rearview
JS007WQK



7" Hd Led Monitor and HD Camera
JS022K



3.5 Lcd Rearview Camera
JS035K



9" Quad Camera LCD Monitor
JS1409Q



5" Monitor Reverse Camera
JS5001-C20



5" Hd Led Monitor + 2 Camera
JS5001CK



5" HD LED Monitor + Camera Kit
JS5001K



5" Reverse Camera Kit Monitor
JS5020K



7" Monitor + Camera Kit
JS7000K



7" Hd LED Monitor
JS7001



Reverse Camera Led 7 12-24 Wireless"
WRCK1



7 inch Quad View LED Monitor
JS7004



7" Led Monitor 12/24V
JS7020



7" Quad LED Monitor
JS7040



7" TFT LCD Reverse Camera
K7000B



5" Waterproof LCD Monitor
MO5001WP

WWW.MRFILTER.COM.AU

SYDNEY (02) 9769 1166

Mr Filter EST 1998
TRUCKING EARTHMOVING MINING
SUPPLIES

BRISBANE (07) 5540 7530



7" Waterproof LCD Monitor
MO7001WP



Reverse Camera (Gun Hilux Rear)
PZQ9089012



Blaupunkt Rc3.0 Rearview
RC3-0



Rear-View Camera
SD20



Axis Surface Mount Camera
SD23



Pro Endurance SD Card 32 GB MLC
SDHC-32MLC



Pro Endurance SD Card 64 GB MLC
SDXC-64MLC



Wireless Reversing Camera
WRC001



Reverse Camera Hilux
EZQ9089012

Cameras, Sensors & Trackers - Dash Camera



Axis HD Dash Camera
DVR101



Axis Full Dash Cam GPS
DVR601



Axis Full HD and HD Dual
DVR602



Super HD Wi-Fi GPS DVR Dash Cam
EAGLE-I1-1



Full HD Forward View Camera
FHD228



Hard Wire Kit for Smart Dash Cams
USB-HWK

WWW.MRFILTER.COM.AU

SYDNEY (02) 9769 1166

Mr Filter EST 1996
TRUCKING EARTHMOVING MINING
SUPPLIES

BRISBANE (07) 5540 7530

Cameras, Sensors & Trackers - Other



Go 4G Mobile HD Security Camera
370999



Go 2 4G/Wi-Fi Mobile Security Camera
590451



Arlo Outdoor Mount (Black)
719996



Crank Angle Sensor
TCAS413

Cameras, Sensors & Trackers - Parking Sensor



Reversing Sensor Kit Audible 12V
10-99044



Reverse Sensor (Camera) Kit
APS200B



4-Sensor Parking System Led
APS400



12/24V 4-Sensor Wired Bus-Truck
APS400T



4 Sensor Reverse Beeper
APS401T



Parking Sensor Extension Lead
APS5M



18mm Parking Sensor
S56



Sensor for APS400T (Axis)
S59

Charging Cables, Phone Holders & Accessories



120cm A to Lightning Coil Usb Cable
0258891



Powered USB 2.0 Extension Cable
XC4120



USB Charger for iphone
ADM75



5m HD Accessory Extension Lead
81047BL

WWW.MRFILTER.COM.AU



Cosol Lightning to USB Cable
COAL12WH



1m Micro USB Cable
COU2MB01



Cosol USB 3.0 Micro Cable 1m
COU3ACB01



OBD2 Driving Recorder Power Cord
OBDCABLE



Apple USB-C Lightning Cable
INMK0X2AMA



Keyed Laptop Lock
KEN64636



Wireless Phone Charger Mat
81120BL



Wireless Phone Charger Cup
81121BL



Wireless Air Vent Phone Charger
81122BL



Wireless Charger Mount
81124BL



Mobile Phone Holder Wireless Charging
AP20AQI



MagMate Dash Mount Smartphone
APMPDM1



Magmate Pro Long arm mobile Phone
APPSM2



Magmate Pro Vent Mount Mobile
APMPVM1



Twin Pack Magnetic Smart Phone
APMUNI



Cigarette Lighter Plug + Leads
81032BL



HD Surface Mount Accessory
81168BL



Twin Socket with Meter
81181BL



Narva Heavy Duty Adaptor
81031BL



Aluminium Merit Socket
82104BL

WWW.MRFILTER.COM.AU

SYDNEY (02) 9769 1166

Mr Filter
EST 1998
TRUCKING EARTHMOVING MINING
SUPPLIES

BRISBANE (07) 5540 7530



Cigarette Lighter Plug
81046BL



Thermoplastic Merit Plug BL (1)
82106BL



Thermoplastic Engel Type Plug
82109BL



Combination Cigarette Lighter Plug
82110BL



GDM Plug 2 Pole + PE Line Cable Gland
931-957-100



HD Surface Mount Accessory Socket
81025BL



Cigarette Lighter Socket
81026BL



12-24V USB Power Adaptor
81038BL



Twin USB Adaptor
81039BL



Aluminium Merit Socket (Power & Earth)
82105BL



Dual USB Socket LED
81102BL



Inline Adaptor 3/16" X 1/8"Npt
EA9470



HD Surface Mount Dual USB Socket
81154BL



HD Twin Surface Mount Sockets
81160BL



Dual Usb In Car Socket Charger
HU6637B



Dual Usb In Car Socket Charger
HU6638B



2.4A Dual USB Car Cigarette Lighter
MP3663



Comsol Single Port USB Wall Charger
COWCS10WHT



Cruzer Blade USB Flash Drive 16GB
SDCZ50P516



Led 24V Load Resistor Blister Twin
LR24-2

WWW.MRFILTER.COM.AU



Dash Fan 12V Two Speed
81064BL



Weatherproof Enclosure Clear Lid
30325



15 Amp Electresafe Power Centre RCD
4420182



Usb & Aux Facia Double Din
ATB3USB



Dc Power Supply 24V
DPS2420



Phone & Gps Holder
PK31702



Arkon Tablet Mount Bundle
TAB806

Fuses & Fuse Accessories

GLASS FUSES



ITEM: 52300BL



Fig. 3



Fig. 4

FUSES & FUSE ACCESSORIES

PART NO.	RATED CURRENT	AMP	TYPE	QTY.
GLASS FUSES				
52103 52103BL	50 Blister (5)	3	140 Glass Internal Soldered Cap	1
52207 52215	50 50	7.5 15	240 Glass Internal Soldered Cap	2
52300BL	Blister (10)	Various	Glass Fuse Assortment Complete: 52302 x 1 52305 x 1 52310 x 1 52315 x 2 52320 x 2 52325 x 2 52330 x 1	
52301 52301BL	50 Blister (5)	1	140 Glass Internal Soldered Cap	3
52302 52302BL	50 Blister (5)	2		
52303 52303BL	50 Blister (5)	3		
52305 52305BL	50 Blister (5)	5		
52307 52307BL	50 Blister (5)	7.5		
52310 52310BL	50 Blister (5)	10		
52315 52315BL	50 Blister (5)	15		
52320 52320BL	50 Blister (5)	20		
52325 52325BL	50 Blister (5)	25		
52330 52330BL	50 Blister (5)	30		
52335 52335BL	50 Blister (5)	35	8PE Glass Internal Soldered Cap	4
52414 52414BL	50 Blister (5)	14		

CERAMIC & BLADE FUSES



Part No. 52600BL



Fig 1

Part No.	Rating (Amps)	Value	Notes	QTY
52600BL	Blade (1.0)	Various	Ceramic Fuse Assortment Comprises: 52605 x 1 52610 x 2 52615 x 4 52625 x 2	5
52608 52608BL	50 Blade (5)	8	9AC Ceramic	
52616 52616BL	50 Blade (5)	25		
52625 52625BL	50 Blade (5)	25		

MICRO BLADE FUSES



Part No. 52500BL

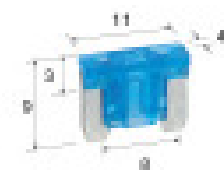
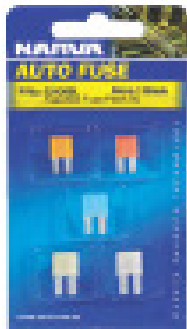

Fig 2

Part No.	Rating (Amps)	Value	Notes	QTY
52500BL	Blade (5)	Various	Micro Blade Fuse Assortment Comprises: 52505 x 1 52510 x 1 52515 x 1 52520 x 1 52525 x 1	8
52505 52505BL	25 Blade (5)	5	Micro Blade	
52507 52507BL	25 Blade (5)	7.5		
52510 52510BL	25 Blade (5)	10		
52515 52515BL	25 Blade (5)	15		
52520 52520BL	25 Blade (5)	20		
52525 52525BL	25 Blade (5)	25		
52530 52530BL	25 Blade (5)	30		

FUSES & FUSE ACCESSORIES

BLADE FUSES



Part No. 52400BL

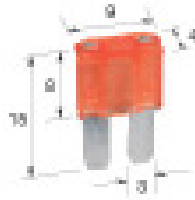

FIG 7

FUSES & FUSE ACCESSORIES

PART NO.	RATED CURRENT	AMPS	TYPE	FIG NO.
MICRO 2 BLADE FUSES				
52400BL	Blister (5)	Various	Micro 2 Blade Fuse Assortment Comprises: 52405 x 1 52430 x 1 52415 x 1 52420 x 1 52425 x 1	
52405 52405BL	25 Blister (5)	5	Micro 2 Blade	7
52407 52407BL	25 Blister (5)	7.5		
52410 52410BL	25 Blister (5)	10		
52415 52415BL	25 Blister (5)	15		
52420 52420BL	25 Blister (5)	20		
52425 52425BL	25 Blister (5)	25		
52430 52430BL	25 Blister (5)	30		



Part No. 51200BL

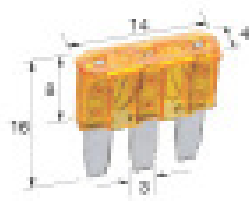
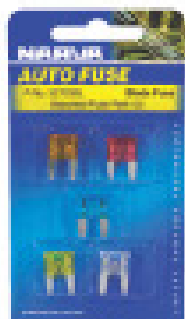

FIG 8

PART NO.	RATED CURRENT	AMPS	TYPE	FIG NO.
MICRO 3 BLADE FUSES				
51200BL	Blister (5)	Various	Micro 3 Blade Fuse Assortment Comprises: 51205 x 1 51207 x 1 51210 x 1 51215 x 3	
51205 51205BL	25 Blister (5)	5	Micro 3 Blade	8
51207 51207BL	25 Blister (5)	7.5		
51210 51210BL	25 Blister (5)	10		
51215 51215BL	25 Blister (5)	15		

BLADE FUSES



Part No. 52700BL

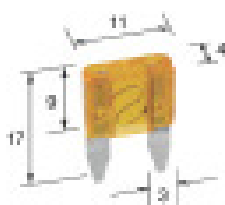

Fig 9

Part No.	Current Rating	ATC	ATC	ATC
MINI BLADE FUSES				
52700BL	Blister (5)	Various	Mini Blade Fuse Assortment Comprises: 52705 x 1 52710 x 1 52715 x 1 52720 x 1 52725 x 1	
52702	50	2	Mini Blade	D
52702BL	Blister (5)			
52703	50	3		
52703BL	Blister (5)			
52705	50	5		
52705BL	Blister (5)			
52707	50	7.5		
52707BL	Blister (5)			
52710	50	10		
52710BL	Blister (5)			
52715	50	15		
52715BL	Blister (5)			
52720	50	20		
52720BL	Blister (5)			
52725	50	25		
52725BL	Blister (5)			
52730	50	30		
52730BL	Blister (5)			

FUSES & FUSE ACCESSORIES

STANDARD ATS BLADE FUSES



Part No. 52800BL

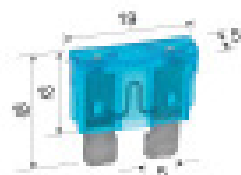

Fig 10

Part No.	Current Rating	ATC	ATC	ATC		
STANDARD ATS BLADE FUSES						
52800BL	Blister (5)	Various	Blade Fuse Assortment Comprises: 52805 x 1 52815 x 2 52820 x 1 52830 x 1			
52803	50	3	Standard ATS Blade	10		
52803BL	Blister (5)					
52805	50	5				
52805BL	Blister (5)					
52807	50	7.5				
52807BL	Blister (5)					
52810	50	10				
52810BL	Blister (5)					
52815	50	15				
52815BL	Blister (5)					
52820	50	20				
52820BL	Blister (5)					
52825	50	25				
52825BL	Blister (5)					
52830	50	30				
52830BL	Blister (5)					
52840	50	40				
52840BL	Blister (5)					

MRFLTR 2014/20 CATALOGUE | 187

WWW.MRFILTER.COM.AU

SYDNEY (02) 9769 1166

Mr Filter EST 1996
TRUCKING EARTHMOVING MINING
SUPPLIES

BRISBANE (07) 5540 7530

BLADE FUSES & FUSE PULLERS



Part No. 52950BL

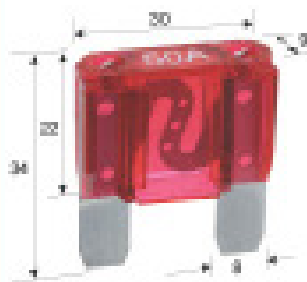

Fig 11

PART NO.	SAFETY REMARKS	AMPS	TYPE	QTY/BL.
MAXI BLADE FUSES				
52920 52920BL	10 Blister (1)	20	Maxi Blade	11
52930 52930BL	10 Blister (1)	30		
52940 52940BL	10 Blister (1)	40		
52950 52950BL	10 Blister (1)	50		
52960 52960BL	10 Blister (1)	60		
52980 52980BL	10 Blister (1)	80		
52990 52990BL	10 Blister (1)	100		

FUSES & FUSE ACCESSORIES



Part No. / Description

54490BL Blister Pack
Standard ATS Blade or Glass Fuse Puller



54492BL Blister Pack
Micro and Mini Blade Fuse Puller

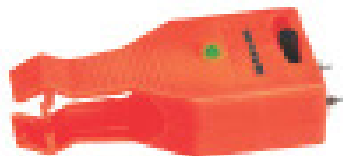

54494BL Blister Pack
Blade Fuse Tester and Puller
Suitable for Micro, Mini, Standard ATS and Maxi Blade fuses. Conveniently tests blade fuses in the block. Indicator L.E.D. glows green when fuse is functional



Adjustable test pins to suit all blade-fuse types

CONVENIENT FUSE ASSORTMENTS

Mr Filter offers the convenience of handy fuse assortments to ensure you are covered whatever the requirement, from retail friendly blister packs through to the larger and extremely popular selection of Fuse Assortment Kits, housed in durable transparent plastic cases. For those refer to pages 213-215

FUSIBLE LINKS



Fig 12

Features longer split to suit most applications

ART NO.	QUANTITY PER PACK	AMPS	TYPE	PG. NO.
FEMALE FUSIBLE LINKS - PLUG IN				
53020 53020BL	10 Blister (1)	30	Female Fuse Plug	12
53030 53030BL	10 Blister (1)	30		
53040 53040BL	10 Blister (1)	40		
53050 53050BL	10 Blister (1)	50		
53060 53060BL	10 Blister (1)	60		
53080 53080BL	10 Blister (1)	80		
53090 53090BL	10 Blister (1)	100		

MALE FUSIBLE LINKS - PLUG IN



Fig 13

MALE FUSIBLE LINKS - PLUG IN				
53130 53130BL	10 Blister (1)	30	Male Fuse Plug	13
53140 53140BL	10 Blister (1)	40		
53150 53150BL	10 Blister (1)	50		
53160 53160BL	10 Blister (1)	60		
53170 53170BL	10 Blister (1)	70		
53180 53180BL	10 Blister (1)	80		
53190 53190BL	10 Blister (1)	100		
53192 53192BL	10 Blister (1)	120		

FUSES & FUSE ACCESSORIES

MRFILTER 50/60/70 CATALOGUE | 189

WWW.MRFILTER.COM.AU

SYDNEY (02) 9769 1166

Mr Filter EST 1996
TRUCKING EARTHMOVING MINING SUPPLIES

BRISBANE (07) 5540 7530

FUSIBLE LINKS

FUSES & FUSE ACCESSORIES

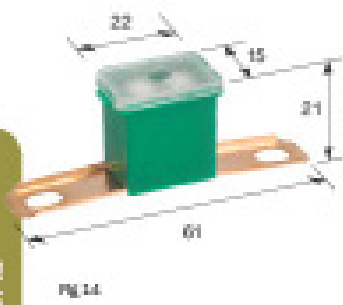

Fig. 14

PART NO.	SAFETY REMARKS	AMPS	TYPE	FIG. NO.
L-TYPE FUSIBLE LINKS - LONG TAB				
53240 53240BL	30 Blister (3)	50	L-Type Fuse Link	14
53250 53250BL	30 Blister (3)	50		
53260 53260BL	30 Blister (3)	50		
53280 53280BL	30 Blister (3)	80		
53290 53290BL	30 Blister (3)	100		

PART NO.	SAFETY REMARKS	AMPS	TYPE	FIG. NO.
L-TYPE FUSIBLE LINKS - SHORT TAB				
53320 53320BL	30 Blister (3)	20	L-Type Fuse Link	15
53330 53330BL	30 Blister (3)	30		
53340 53340BL	30 Blister (3)	40		
53350 53350BL	30 Blister (3)	50		
53360 53360BL	30 Blister (3)	60		
53370 53370BL	30 Blister (3)	70		
53380 53380BL	30 Blister (3)	80		
53390 53390BL	30 Blister (3)	100		
53392 53392BL	30 Blister (3)	120		

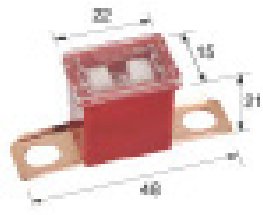

Fig. 15

FUSIBLE LINKS

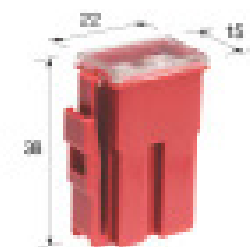

Fig 16

PART NO.	QUANTITY PER PACK	AMP	TYPE	PC NO.
FEMALE FUSIBLE LINKS - PLUG IN WITH LOCK				
53345 53345BL	10 Blister (1)	45	Female Fuse Plug with Lock	16
53365 53365BL	10 Blister (1)	65		
53375 53375BL	10 Blister (1)	75		

MINI FEMALE FUSIBLE LINKS - PLUG IN (TYPE 1)



Fig 17

53420 53420BL	10 Blister (1)	20	Female Mini Fuse Plug (Type 1)	17
53430 53430BL	10 Blister (1)	30		
53440 53440BL	10 Blister (1)	40		
53450 53450BL	10 Blister (1)	50		
53460 53460BL	10 Blister (1)	60		
53480 53480BL	10 Blister (1)	80		
53490 53490BL	10 Blister (1)	100		

FUSES & FUSE ACCESSORIES

HARVE SCHWISS CATALOGUE | 191

WWW.MRFILTER.COM.AU

SYDNEY (02) 9769 1166

Mr Filter EST 1996
TRUCKING EARTHMOVING MINING
SUPPLIES

BRISBANE (07) 5540 7530

FUSIBLE LINKS



Fig 28

FUSES & FUSE ACCESSORIES



Fig 29

PART NO.	SAFETY RATING	AMPS	TYPE	PKT NO.
MINI FEMALE FUSIBLE LINKS - PLUG IN WITH LOCK				
53525 53525BL	10 Blister (1)	25	Female Mini Fuse Plug with Lock	18
53530 53530BL	10 Blister (1)	30		
MINI FEMALE FUSIBLE LINKS - PLUG IN (TYPE 2)				
53620 53620BL	30 Blister (3)	20	Female Mini Fuse Plug (Type 2)	29
53630 53630BL	30 Blister (3)	30		
53640 53640BL	30 Blister (3)	40		
53650 53650BL	30 Blister (3)	50		
53660 53660BL	30 Blister (3)	60		
53680 53680BL	30 Blister (3)	80		
53690 53690BL	30 Blister (3)	200		

FUSIBLE LINKS



Fig. 20

Part No.	Quantity Per Pack	Rating	Type	Part No.
LJC MINI FUSIBLE LINKS				
51020 510208L	10 Blister (3)	20	Female Mini LJC Fusible Link	20
51025 510258L	10 Blister (3)	25		
51030 510308L	10 Blister (3)	30		
51040 510408L	10 Blister (3)	40		
51050 510508L	10 Blister (3)	50		
51060 510608L	10 Blister (3)	60		



Fig. 21

Part No.	Quantity Per Pack	Rating	Type	Part No.
MJC MINI FUSIBLE LINKS				
51115 511158L	10 Blister (3)	15	Female Mini MJC Fusible Link	21
51120 511208L	10 Blister (3)	20		
51125 511258L	10 Blister (3)	25		
51130 511308L	10 Blister (3)	30		
51140 511408L	10 Blister (3)	40		

FUSES & FUSE ACCESSORIES

ANS, ANM, ANL & ANG FUSES

2019 sees an extensive range of new fuse options added, including the new ANM and Bolt Down battery fuses as well as updates of the popular ANS, ANL and ANG ranges. Turn to page 206 to find a collection of premium fuse holders to suit in both single and twin configurations.



See page 206 for Fuse-Block options

FUSES & FUSE ACCESSORIES



Fig 1

PART NO.	QUANTITY PER FUSE	AMP	TYPE	FIG NO.
ANS FUSES				
53806 53806BL	1 Blister (1)	50	Bolt-on fuse. Copper alloy construction with tin plating and inspection window Use with Fuse box P/Ns. 54430 & 54432 (See page 206)	1
53808 53808BL	1 Blister (1)	60		
53810 53810BL	1 Blister (1)	80		
53812 53812BL	1 Blister (1)	100		
53814 53814BL	1 Blister (1)	125		
53816 53816BL	1 Blister (1)	150		

ALL NEW

PART NO.	QUANTITY PER FUSE	AMP	TYPE	FIG NO.
ANM FUSES				
53830 53830BL	1 Blister (1)	80	Bolt-on fuse. Copper alloy construction with tin plating and inspection window Use with Fuse box P/Ns. 54480 (See page 206)	2
53832 53832BL	1 Blister (1)	100		
53834 53834BL	1 Blister (1)	125		
53836 53836BL	1 Blister (1)	150		
53838 53838BL	1 Blister (1)	175		
53840 53840BL	1 Blister (1)	200		
53842 53842BL	1 Blister (1)	250		



Fig 2

BATTERY, ANL & ANG FUSES



Fig 3

PART NO.	QTY PER PACKAGE	AMPS	TYPE	REUSE
ANL FUSES				
53908	1	80	Bolt-on fuse. Copper alloy construction with gold plated separator and inspection window. Ideal for high current applications such as inverters and car audio.	3
53908BL	Bleeder (3)			
53910	1	100		
53910BL	Bleeder (3)			
53912	1	125		
53912BL	Bleeder (3)			
53915	1	150		
53915BL	Bleeder (3)			
53918	1	175		
53918BL	Bleeder (3)			
53920	1	200	Use with Fuse box P/Mo. 54410 & 54435 (See page 208)	
53920BL	Bleeder (3)			
53925	1	250		
53925BL	Bleeder (3)			



Fig 4

PART NO.	QTY PER PACKAGE	AMPS	TYPE	REUSE
ANG FUSE STRIPS				
54002	10	30	ANG Fuse Strips Use with Fuse box P/Mo. 54470 & 54472 (See page 208)	4
54003		40		
54004		50		
54005		60		
54006		80		
54007		110		
54008		150		
54009		175		



Fig 5

PART NO.	QTY PER PACKAGE	AMPS	TYPE	REUSE
BOLT DOWN BATTERY FUSE				
54080BL	Bleeder (3)	80	Bolt-down battery fuse. Ideal for high current applications such as hydraulic rams or inverters. Voltage: 12-24V Operating Temperature: -40°C to 125°C (See page 202)	5
54100BL		100		
54125BL		125		
54150BL		150		
54175BL		175		
54200BL		200		
54250BL		250		

HEAVY DUTY/SD CATALOGUE | 195

WWW.MRFILTER.COM.AU

SYDNEY (02) 9769 1166

Mr Filter EST 1996
TRUCKING EARTHMOVING MINING SUPPLIES

BRISBANE (07) 5540 7530

FUSE HOLDERS

Mrna's already extensive range of fuse holders and boxes continues to expand, offering one of the largest selections on the market. Manufactured to the highest quality standards, there is a fuse holder to suit everything from Glass to Blade type fuses. The extended range includes the introduction of new In-Line Fuse holders incorporating convenient LED indicators to enable quick fault detection, a greater choice of 'Add-A-Circuit' fuse holders, and the introduction of premium Fuse Block and Fuse Box options.

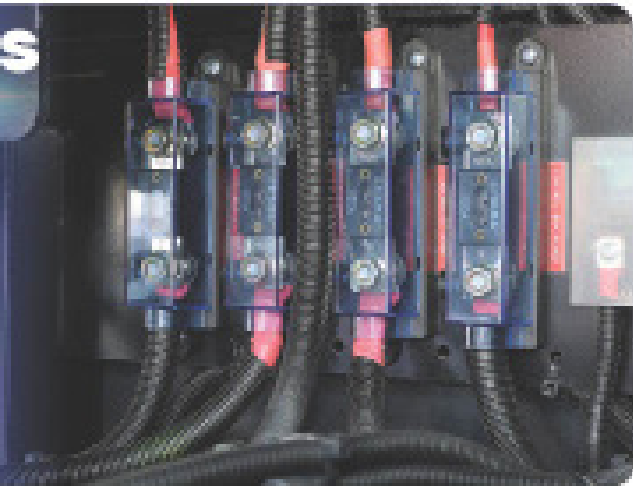

FUSES & FUSE ACCESSORIES

PART No. / DESCRIPTION

54380BL Blister Pack

In-Line Glass Fuse Holder with 10 Amp Fuse (P.No. 53310)
Amperage rating 10A

54380/50 As above Bulk Pack of 50, fuses not included



54382BL Blister Pack

In-Line Glass Fuse Holder with 30 Amp Fuse (P.No. 53330)
Amperage rating 30A
Galvalite construction

54382/50 As above Bulk Pack of 50, fuses not included



54384BL Blister Pack

In-Line Waterproof Glass Fuse Holder
Supplied with crimp terminals
Amperage rating 30A

54384/10 As above Bulk Pack of 10



(fuses not included)

54392BL Blister Pack

Panel Mount Glass Fuse Holder with Push On Terminals and 10 Amp Fuse (P.No. 53310)
Amperage rating 10A
Mounting opening 15mm dia.

54392/50 As above Bulk Pack of 50, fuses not included



FUSE HOLDERS

PART NO. / DESCRIPTION



54394BL Blister Pack
Panel Mount Standard ATS Blade Fuse Holder with Push on Terminals and 15 Amp Fuse (P/No. 52815)

Amperage rating 30A

54394/50 As above Bulk Pack of 50, fuses not included



(Fuse not included)

54401BL Blister Pack
'Quick Connect' In-Line Standard ATS Blade Fuse Holder

Amperage rating 30A

54401/50 As above Bulk Pack of 50



(Fuse not included)

54402BL Blister Pack
In-Line Standard ATS Blade Fuse Holder for use with Female 6.3 mm Blade Terminal

Can be interlocked face to face

Amperage rating 30A

54402/50 As above Bulk Pack of 50



(Fuse not included)

54403BL Blister Pack
In-Line Standard ATS Blade Fuse Holder

Amperage rating 30A

54403/50 As above Bulk Pack of 50



(Fuse not included)

54404BL Blister Pack
In-Line Standard ATS Blade Fuse Holder

Amperage rating 30A

54404/50 As above Bulk Pack of 50

FUSES & FUSE ACCESSORIES

MARVEL 50PRV30 CATALOGUE | 201

WWW.MRFILTER.COM.AU

SYDNEY (02) 9769 1166

Mr Filter EST 1996
TRUCKING EARTHMOVING MINING
SUPPLIES

BRISBANE (07) 5540 7530

FUSE HOLDERS

FUSES & FUSE ACCESSORIES



(Fuse not included)

PART NO. / DESCRIPTION

54405BL Blister Pack
Pre-Wired In-Line Waterproof Standard ATS Blade Fuse Holder
Amperage rating 30A

54405/10 As above Bulk Pack of 10



54406BL Blister Pack
In-Line Standard ATS Blade Fuse Holder with Weatherproof Cap
Amperage rating 30A

54406/10 As above Bulk Pack of 10

54406LED6L As above with LED indicator

54406LED/10 As above Bulk Pack of 10

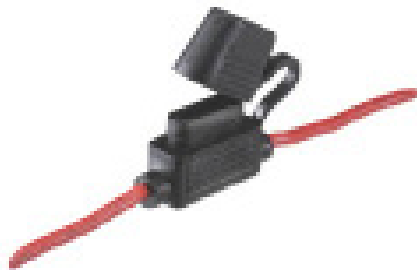

(Fuse not included)



LED indicator

54407BL Blister Pack
Waterproof Standard ATS Blade Fuse Holder
Supplied with crimp terminals. Can be terminated to ensure best possible waterproofing.
Amperage rating 30A

54407/10 As above Bulk Pack of 10



(Fuse not included)

NEW **54427BL** Blister Pack
Battery Fuse Holder Block
Plastic body with copper alloy connector
Amperage rating 600A

54427/10 As above Bulk Pack of 10

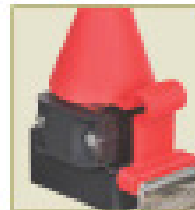
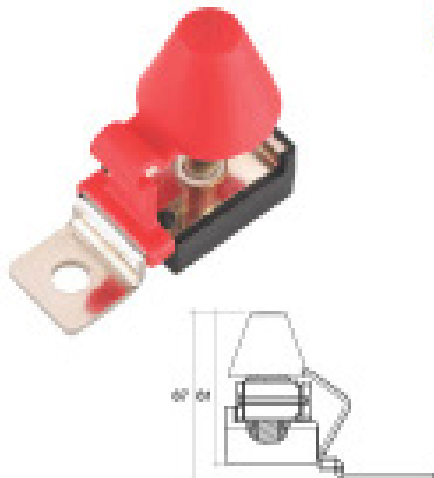

Fuse pictured is 250 Amp, fuse holder rated to 600 Amp



Fuse not included - see page 165 for fuse range

FUSE HOLDERS

PART NO. / DESCRIPTION

54410BL Bulk Pack
Low Profile In-Line Micro Blade Fuse Holder with Weatherproof Cap
 Amperage rating 30A

54410B As above Bulk Pack of 10



Fuse not included

54412BL Bulk Pack
In-Line Mini Blade Fuse Holder with Weatherproof Cap
 Amperage rating 30A

54412B As above Bulk Pack of 10

54412LED As above with LED indicator

54412LED/10 As above Bulk Pack of 10



LED indicator

Fuse not included

54413
'Audio' In-Line Maxi Blade Fuse Holder with Transparent Cover

Ideal for audio installations and other high current applications. Features an attractive transparent cover with surface and wall mounting options.
 Amperage rating 80A



Fuse not included



54414BL Bulk Pack
In-Line Maxi Blade Fuse Holder with Weatherproof Cap
 Amperage rating 80A

54414 As above Bulk Pack (1)



Fuse not included

FUSES & FUSE ACCESSORIES

MARKET 2019/20 DATALOGUE | 203

WWW.MRFILTER.COM.AU

SYDNEY (02) 9769 1166

Mr Filter EST 1996
 TRUCKING EARTHMOVING MINING
 SUPPLIES

BRISBANE (07) 5540 7530

'ADD-A-CIRCUIT' FUSE HOLDERS

Mrna has updated its range of Add-A-Circuit fuse holders to include micro blade fuse options, joining the existing mini blade and standard ABS blade fuse offerings. Micro blade fuse setups are commonly found in space restricted automotive applications.

Add-A-Circuit fuse holders allow you to easily add a protected circuit to existing fuse holders/boxes without the need for splicing, by way of piggybacking – simply plug the circuit into an existing fuse slot or holder. Add-A-Circuits come with a 5A and a 10A fuse and feature a combined maximum ampereage rating of 20A.

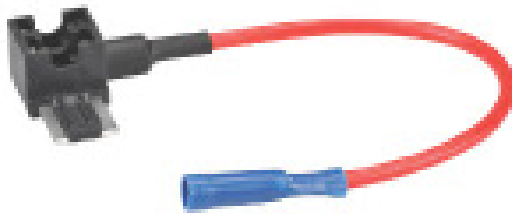
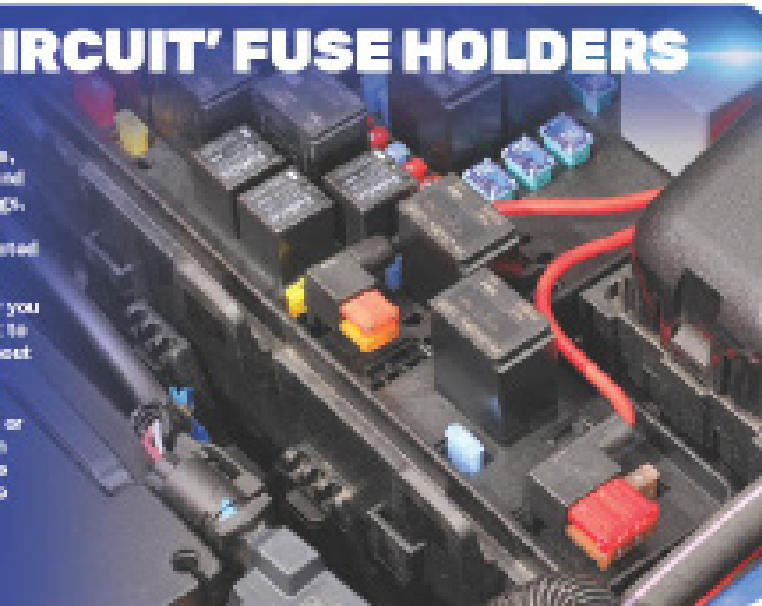

PART NO. / DESCRIPTION



54411BL

'Add-a-Circuit' Micro Blade Fuse Holder with 5 and 10 Amp Fuses (P/Ns: 52505, 52510)

Allows you to easily add a protected circuit to existing fuse holders/boxes, without the need for splicing. Simply plug into existing fuse slots

Combined max ampereage rating 20A

54411/10 As above Bulk Pack of 10, fuses not included

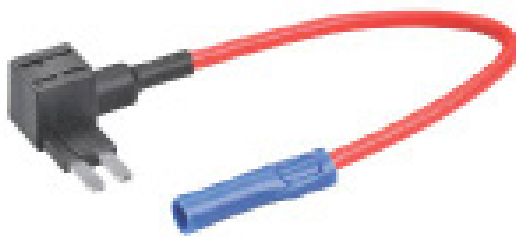

54415BL

'Add-a-Circuit' Micro 2 Blade Fuse Holder with 5 and 10 Amp Fuses (P/Ns: 52405, 52410)

Allows you to easily add a protected circuit to existing fuse holders/boxes, without the need for splicing. Simply plug into existing fuse slots

Combined max ampereage rating 20A

54415/10 As above Bulk Pack of 10, fuses not included



FUSE HOLDERS

PART NO. / DESCRIPTION



54425BL

'Add-a-Circuit' Micro 3 Blade Fuse Holder with 5 and 10 Amp Fuses (P/Nos 51205, 51210)

Allows you to easily add a protected circuit to existing fuse holders/boxes, without the need for splicing. Simply plug into existing fuse slots.

Combined max. amperage rating 20A.

54425/10 As above Bulk Pack of 10, fuses not included

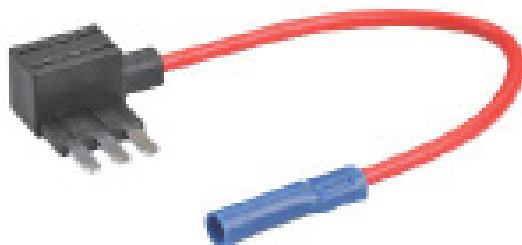

54408BL

'Add-a-Circuit' Mini Blade Fuse Holder with 5 and 10 Amp Fuses (P/Nos 52705, 52710)

Allows you to easily add a protected circuit to existing fuse holders/boxes, without the need for splicing. Simply plug into existing fuse slots.

Combined max. amperage rating 20A.

54408/10 As above Bulk Pack of 10, fuses not included

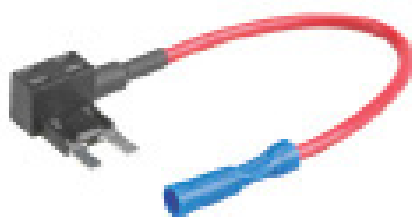

54409BL

'Add-a-Circuit' Standard AIS Blade Fuse Holder with 5 and 10 Amp Fuses (P/Nos 52805, 52810)

Allows you to easily add a protected circuit to existing fuse holders/boxes, without the need for splicing. Simply plug into existing fuse slots.

Combined max. amperage rating 20A.

54409/10 As above Bulk Pack of 10, fuses not included

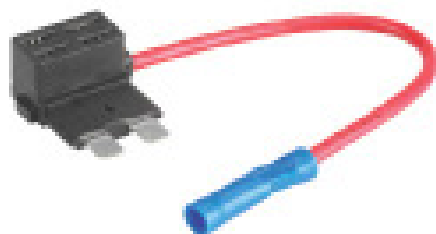

FUSES & FUSE ACCESSORIES

MARKET 2019/20 DATELOGUE | 205

WWW.MRFILTER.COM.AU

SYDNEY (02) 9769 1166

Mr Filter EST 1996
TRUCKING EARTHMOVING MINING
SUPPLIES

BRISBANE (07) 5540 7530

Fuses & Fuse Accessories - Fuse Assortments



100 Pc Mini Auto Fuse Set
16022



150 Pc Complete Auto Fuse Kit
16027



Mini Blade Fuse Assortment 100 Pieces
52016



Popular Fuse Assortment 360 Pieces
52020



Specialised Fuse Assortment
52030



ANS Fuse Assortment 49 Pieces
52033



ANM Fuse Assortment - 20 Pieces
52034



Master Fuse Assortment - 300 Pieces
52035



Fuse Kit Micro 2 Wedge 71 Pieces
BM2WF-KIT



Auto Fuse Assortment
CA105



Auto Fuse Master Kit
CA2005



149pc Master Fuse Kit
CH21405



Fuse Assortment Kit 280Pcs
FU9503



Fuse Assortment Kit 120 Pieces
FU9504



Mini Blade Fuse Assortment Kit
FU9505



Fuse/Link Assortment Kit (68 Pcs)
FU9506



Mini Blade Fuse Kit 100 Mixed
MBF100



Micro Blade Fuse Assortment - 71 Pcs
52014



Standard, Mini & Micro Blade Fuse Kit
52022

WWW.MRFILTER.COM.AU

Fuses & Fuse Accessories - Mega Fuses



OEX Mega Fuse, 200A Bolt
ACX6525BL



OEX Mega Fuse, 250A Bolt
ACX6527



OEX Mega Fuse, 500A Bolt
ACX6529BL



Megafuse White 175Amp 1Pce
FU6175



Megafuse Pink 250Amp 1Pce
FU6250

Fuses & Fuse Accessories - Midi Fuses



Pkt 10 Midi Fuse White 80 Amp
FU6080-10



500A Fuse To Suit Porta Power
1273



50A ANS Type Fuse
53806



60A Inline ANS Fuse
53808



ANL Fuse 150A 1 Pce
53915



30A ANG Fuse Strips 10Pce
54002



60A ANG Fuse Strips 10Pce
54005



ANG Fuse Strips 110A 10 Pce
54007



Midi Fuse, 50A Bolt On - 10Pce
ACX6505



Midi Fuse, 50A Bolt On
ACX6505BL



Midi Fuse 100A Bolt On
ACX6510BL



Fuse ANL Series 200A
ANL-200

WWW.MRFILTER.COM.AU

Globes, LED & Halogen

STOP/TAIL & INDICATOR GLOBES



MR FILTER PART NO. (C)	DISCONTINUED PART NO.	WATT	WATTAGE POSITION	BASE TYPE	MR FL DIS ST	FIG NO.	LED POWER (WATT)
47152	-	12W	15W		-		
47156	-	12W	320P (35W)		-		
47382	47382BL (C)	12W	21W		P21W		✓
17635 <i>Proton</i>	17638BL (C) <i>Proton</i>	12W	21W		P21W		✓
17382 <i>Easy-Dry</i>	17382BL (C) <i>Easy-Dry</i>	12W	21W	BA15s 5-25mm	P21W	1	✓
47241	47241BL (C)	24W	21W		P21W		✓
17643 <i>Proton</i>	17643BL (C) <i>Proton</i>	24W	21W		P21W		✓
17241 <i>Easy-Dry</i>	-	24W	21W				✓
47339	47339BL (C)	24W	320P (35W)		-		
47383	47383BL (C)	12W	21W Amber	BA15s 8-25mm	-	2	
47384	47384BL (C)	12W					✓
17384 <i>Easy-Dry</i>	17384BL (C) <i>Easy-Dry</i>	12W					✓
17638 <i>Proton</i>	17638BL (C) <i>Proton</i>	12W	21W Amber	BA15s 8-25mm	PY21W	3	✓
17649 <i>Proton</i>	-	24W					
47385	47385BL (C)	12W	21W Amber	BA15s 8-25mm Phantom Invisible Amber	-	4	✓
47006	-	12W	21/21W		-		
47157	-	12W	3240P (350W)		-		
47380	47380BL (C)	12W	21/5W				✓
17916 <i>Proton</i>	17916BL (C) <i>Proton</i>	12W	21/5W		P21/5W		✓
17380 <i>Easy-Dry</i>	17380BL (C) <i>Easy-Dry</i>	12W	21/5W	BA215d Offset plus 8-25mm		5	✓
47334	-	24W	24/5W		-		
47336	47336BL (C)	24W	21/5W				✓
17925 <i>Proton</i>	17925BL (C) <i>Proton</i>	24W	21/5W		P21/5W		✓
17336 <i>Easy-Dry</i>	-	24W	21/5W				✓
47386	47386BL (C)	12W	21/4W	BA215d Offset plus 5-25mm	P21/4W	6	
47387	47387BL (C)	12W	21/5W Red	BA15d Offset plus	-	7	
47335	47335BL (C)	12W	21W		-		
47333	-	24W	320P (35W)	BA15d 8-25mm	-	8	
47381	47381BL (C)	12W	20/5W	BA15d 5-25mm	-	9	

*Height variations in dimensions may occur between standard and premium globe types.

AUTOMOTIVE GLOBES

INTERIOR/PARK GLOBES



ORIG. PART NO. (2)	BLINDS PART NO.	VOLT	WATTAGE/COLOUR	BASE TYPE	W&S (1) (2) (3)	EQ. NO.	LED EQUIV. (WATTAGE)
47003	-	12V	15CP (12W)	BA15s	-	10	
47004	-	12V	15CP (12W)	BA15d	-	11	
47207	47207BL (2)	12V	5W	BA15s T-16mm	R5W		✓
17171	17171BL (1)	12V	5W		R5W		✓
47613	47613BL (2)	12V	10W		R10W	12	
47149	47149BL (2)	24V	5W		R5W		
17181	17181BL (1)	24V	5W	R5W			
47618	47618BL (2)	24V	10W	R10W			
47209	47209BL (2)	12V	5W	BA15d T-16mm	R5W		
47210	-	12V	10W		-	12	
47150	-	24V	5W		R5W		

AUTOMOTIVE GLOBES

INSTRUMENT/LICENCE PLATE GLOBES

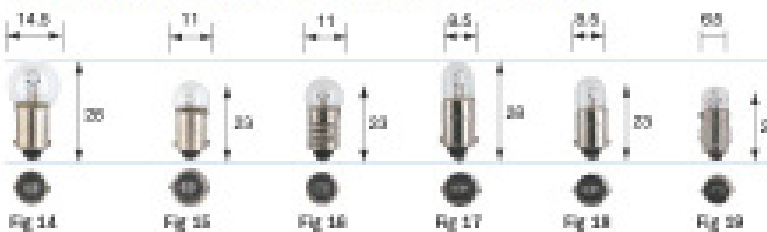

ORIG. PART NO. (2)	BLINDS PART NO.	VOLT	WATTAGE/COLOUR	BASE TYPE	W&S (1) (2) (3)	EQ. NO.	LED EQUIV. (WATTAGE)
47989	47989BL (2)	12V	5W	BA9s G14.5mm	-	14	
47227	-	24V	5W	BA9s G11mm	-	15	
47643	47643BL (2)	12V	3W	BA9s G11mm	-	16	
47987	-	12V	2.2W	E10 G11mm	-	17	
47233	47233BL (2)	12V	4W	BA7s T-8.5mm	T4W		
47249	47249BL (2)	24V	4W				
47230	-	12V	2W	BA7s T-8.5mm	-	18	
47234	-	24V	2W				
47281	47281BL (2)	12V	3W	BA7s T-8.5mm	-	19	
47283	-	24V	3W				

*Slight variations in dimensions may occur between standard and premium globe types

FESTOON GLOBES

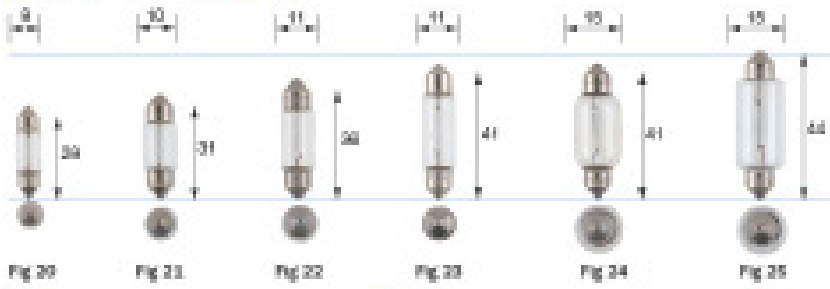

OSPD PART NO. (2)	OSD/OSD PART NO.	VOLT	WATTAGE W/W	BASE TYPE	AMP IN E.T. (1)	FIG. NO.	LED OPTION SEE PG. 175
47263	47263BL (2)	12V	5W		-		
47264	47264BL (2)	12V	5W	(8 x 28mm) S7-8 T-5mm	-	20	
47268	47268BL (2)	24V	5W		-		
47269	47269BL (2)	12V	5W	(10 x 31mm) T-10mm	-	21	✓
47254	47254BL (2)	12V	5W		05W		✓
47825	-	12V	5W	(11 x 38mm) S7-5.8 T-11mm	-	22	
47653	47653BL (2)	24V	5W		05W		✓
47826	-	24V	5W		-		
47258	47258BL (2)	12V	5W		-		✓
47266	-	12V	5W	(11 x 41mm) S7-5.8 T-11mm	-	23	
47260	47260BL (2)	24V	5W		-		✓
47524	-	24V	5W		-		
47265	-	12V	5W		-		
47270	47270BL (2)	12V	18W		-		
47278	47278BL (2)	12V	21W	(15 x 41mm) S7-5.8 T-15mm	021W	24	
47988	47988BL (2)	24V	18W		-		
47280	47280BL (2)	24V	21W		-		
47271	47271BL (2)	12V	18W		-		
47273	47273BL (2)	12V	21W	(15 x 44mm) S7-5.8 T-15mm	021W	25	
47272	-	24V	21W		-		

*Height variation in dimensions may occur between standard and premium globe types.

AUTOMOTIVE GLOBES

WEDGE GLOBES

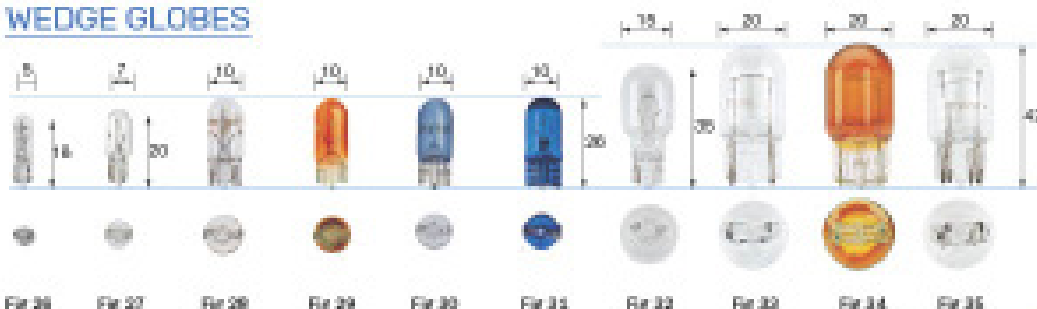

AUTOMOTIVE GLOBES

Q&A PART NO. (2)	MANUFACTURER PART NO.	VOLT	WATTS/20°C	BASE TYPE	480-51 52-57	FIG NO.	L.C.O. (P/AMC 388 PG. 175)
47286	47286BL (2)	12V	1.2W		W1.2W		
47289	-	12V	2.5W	W2 x 4.6d T-5mm	W2.5W	26	
47508	-	24V	1.2W		W1.2W		
47287	47287BL (2)	12V	1.7W	T-6.5mm	-	27	
47504	47504BL (2)	12V	3W		W3W		
47501	47501BL (2)	12V	5W		W5W		✓
17177	17177BL (1)	12V	5W		W5W	28	✓
47505	-	24V	3W		W3W		
47502	47502BL (2)	24V	5W		W5W		✓
17197	17197BL (1)	24V	5W		W5W		✓
47510	47510BL (2)		5W Amber	W2.1 x 9.5d T-30mm	WY5W	29	
	17199BL (1)		5W Amber	W2.1 x 9.5d T-30mm	W5W	30	
	17199BL2 (2)		5W Amber	W2.1 x 9.5d T-30mm	W5W	31	
	17199BL (1)		5W Amber	W2.1 x 9.5d T-30mm	W5W	31	
	17199BL3 (2)		5W Amber	W2.1 x 9.5d T-30mm	W5W	31	
47525	-	12V	12CP (9W)	W2 x 15d T-15mm	-	32	
47526	47526BL (2)	12V	24CP (18W)		-		✓
47530	47530BL (2)	12V	21W	W3 x 16d T-25mm	W21W	33	✓
17440	17440BL (1)	12V	21W	W3 x 16d T-25mm	W21W		✓
47532	47532BL (2)	12V	21W Amber	W3 x 16d T-25mm	WY21W	34	
47534	47534BL (2)	12V	31.5W	W3 x 16d T-25mm	W31.5W	35	✓
17443	17443BL (1)	12V	31.5W	W3 x 16d T-25mm	W31.5W		✓

*Sign variations or dimensions may occur between standard and premium globe types

WEDGE GLOBES



ROAD PART NO. (2)	BULB/BOX PART NO. (2)	VOL	OUTPUT	WATT/OUTPUT/TYPE	BASE DIM. (2)	FIG NO.
47555	47555BL (2)	12V	27W	W2.5 x 16d	P27W	26
47556	47556BL (2)	12V	27W Amber	W2.5 x 16d	P27W	27
47557	47557BL (2)	12V	23/7W	W2.5 x 16q	P23/7W	28
47558	47558BL (2)	12V	27/7W Amber	W2.5 x 16q	P27/7W	29

AUTOMOTIVE GLOBES

PREMIUM INCANDESCENT GLOBES

In response to customer feedback the range of "Premium" globes has been upgraded. With an increased production quality these globes are designed to give the seller and user peace of mind and eliminate the early failures.

Premium globes are made in Europe to the highest quality standards and increased precision making them ideal for both trade and retail markets. Not only do these globes provide elimination of early failures they also have an increased life of up to 2 times that of a standard Narva incandescent globe.

To assist with merchandising and stock holding the range has been rationalised to only include the truly fast moving part numbers.

The upgraded Narva Premium globe range guarantees increased performance and provides exceptional value for money and peace of mind.

NARVA 2019/20 CATALOGUE | 157

WWW.MRFILTER.COM.AU



SYDNEY (02) 9769 1166

BRISBANE (07) 5540 7530

DASH PANEL GLOBES

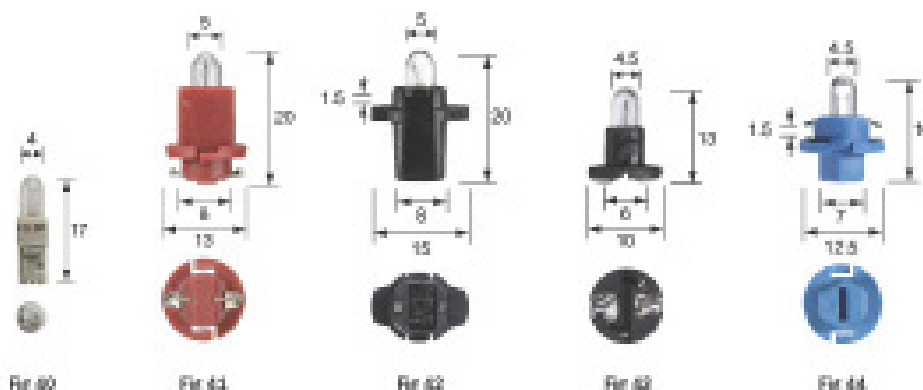

PART NO.	VOLT	WATT	BASE TYPE	BASE COLOUR	FIG NO.
47702	12V	1.2W	HW2 x 4.6d	White	40
47706	24V	1.2W			
47713	24V	0.4W	ESR (BA)	Red	41
47714	24V	1.2W	ESR (BA)	Yellow	
47724	12V	1.2W	ES.31 (BA 1.0d)	Black	42
47734	12V	1.2W	T.1/4 HW	Black	43
47738	12V	1.2W	ES. 41	Light Blue	44

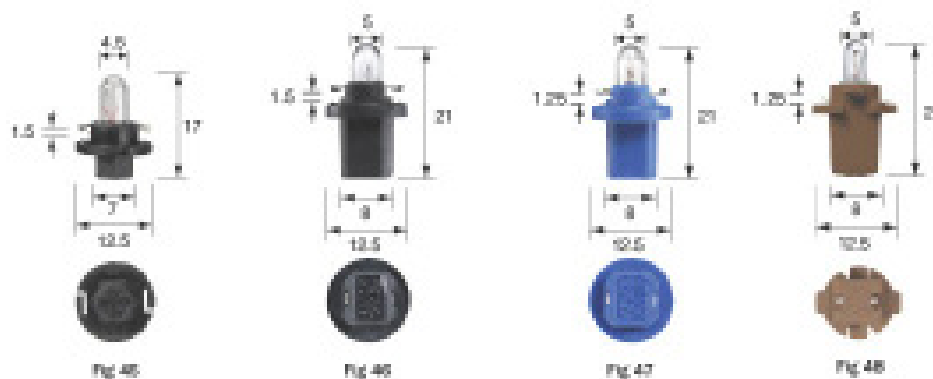

PART NO.	VOLT	WATT	BASE TYPE	BASE COLOUR	FIG NO.
47744	12V	1.2W	ES. 44	Black	45
47748	12V	1.5W		Beige	
47762	12V	1.2W	ES.5d (BA 10d)	Black	46
47766	12V	1.5W		Beige	
47770	12V	2W		Green	
47774	24V	1.2W		Gray	
47780	12V	1.2W	ES. 5d	Blue	47
47784	12V	2W		Green	
47786	24V	1.2W	ES. 5d	Brown	48
47798	24V	1.2W		ES. 7d	

DASH PANEL GLOBE ASSORTMENTS



PART NO. / DESCRIPTION

47705

12/24 Volt Dash Panel Globe Assortment

Ideal for the truck and bus market, the assortment includes the most popular 12V dash panel globes and the complete range of 24V dash panel globes. Re-coding is made easy with a label that identifies the globe with an image, part number and description.

Compass (units):

47702 x 5	47726 x 5	47774 x 5
47706 x 5	47744 x 5	47780 x 5
47713 x 5	47748 x 5	47784 x 5
47714 x 5	47762 x 5	47786 x 5
47724 x 5	47766 x 5	47788 x 5
47734 x 5	47770 x 5	

AUTOMOTIVE GLOBES

THE EFFECT OF INCREASED VOLTAGE ON GLOBE LIFE

Overvoltage/Voltage Spikes are the biggest enemy of a halogen bulb. What else affects a bulb's lifetime?

- The typical lifetime of a high quality H4 bulb (DCM) is around 750 hrs, and 550 hours for H7. For 12V halogen bulbs, the lifetime is measured at a specified test voltage of 13.2V.
- No matter if it's a standard or a high performance bulb, the lifetime of all filament bulbs is strongly dependent on the operating voltage in the car.
- Even at just 5% over-voltage (12.86V), the lifespan of a lightbulb will be cut in half. So the biggest enemy of a bulb's lifespan is overvoltage or voltage spikes.
- Also it's very important to remember that the voltage to the light bulb can vary significantly between automotive brands, models & even individual cars.

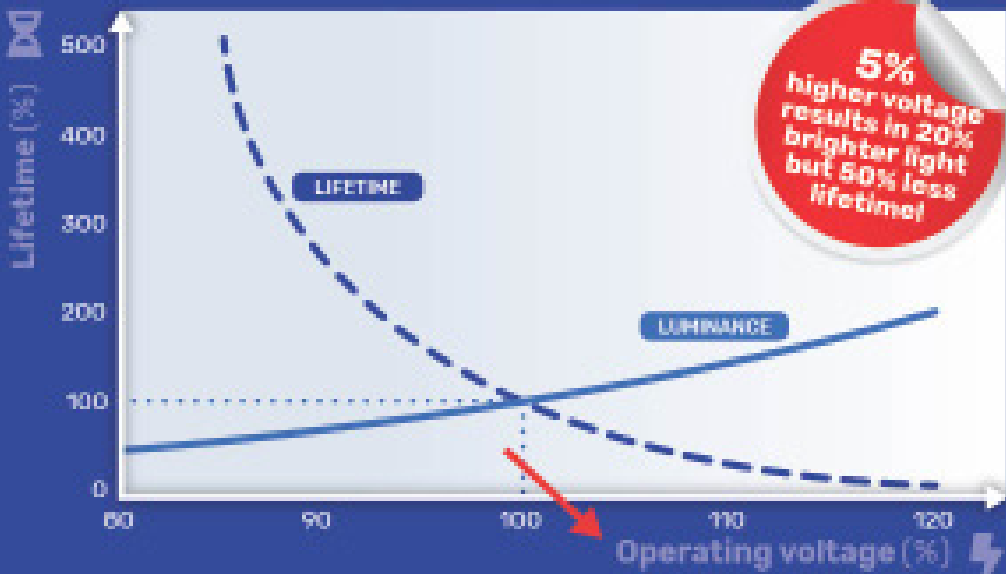

If a vehicle operates at a higher voltage, lifetime of filament globes are best suited to reduce early globe failure

H1 HALOGEN GLOBES

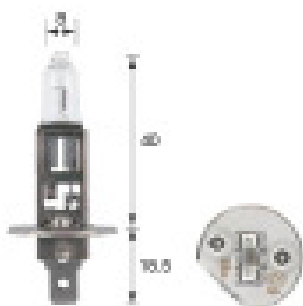

Fig 1



* New feature Plus 30 technology as standard

MRFC PART NO.	ELCATED PART NO.	VOLT	WATTS	BASE TYPE	APPLICABLE BT	FIG NO.
48320 [†]	48320BL [†]	12V	55W	P14.5s Plus 30	H1	1
48322	48322BL	12V	55W	P14.5s EverLife	H1	
48350	48350BL	12V	100W	P14.5s	-	
48701	48701BL	24V	55W	P14.5s	-	
48702	48702BL	24V	70W	P14.5s	H1	
48750	48750BL	24V	100W	P14.5s	-	

H1 PERFORMANCE GLOBES

MRFC PART NO.	ELCATED PART NO.	VOLT	WATTS	BASE TYPE	APPLICABLE BT	FIG NO.
48322BL2 ^{**}	48322BL	12V	55W	P14.5s EVERLIFE	H1	1
48334BL2 ^{**}	48334BL	12V	55W	P14.5s PLUS 100 Longer Life		
48540BL2 [*]	48540BL	12V	55W	P14.5s PLATINUM PLUS 130		
48530BL2 [*]	48530BL	12V	55W	P14.5s BLUE PLUS 110		
48630BL2 [*]	48630BL	12V	55W	P14.5s ARCTIC PLUS 50		
48470BL2 [*]	48470BL	12V	55W	P14.5s INTENSE PLUS 30		
48520BL2 [*]	48520BL	12V	55W	P14.5s SAPPHIRE PLUS 50		
48705BL2	48705BL	24V	70W	P14.5s 24V PLUS 100 Longer Life		

* Pack includes two halogen globes and two 12V 55W T-10mm Arctic Blue park lamp globes

** Pack includes two halogen globes and two 12V 55W T-10mm Long Life park lamp globes

H2 HALOGEN GLOBES

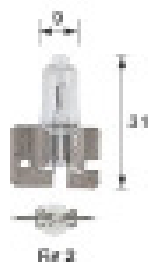
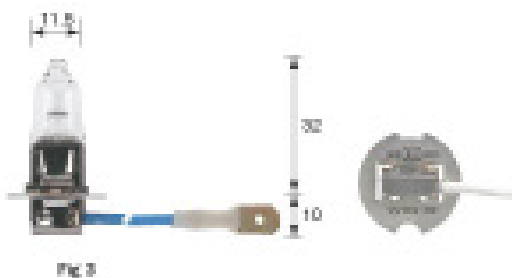

Fig 2

MRFC PART NO.	ELCATED PART NO.	VOLT	WATTS	BASE TYPE	APPLICABLE BT	FIG NO.
48420	48420BL	12V	55W	x511	H2	2
48450	48450BL	12V	100W			
48720	48720BL	24V	70W			
48760	48760BL	24V	100W			

H3 HALOGEN GLOBES



ORDER PART NO.	GLASS PART NO.	VOLT	WATTS	BASETYPE	MR FILTER 30	FIG. NO.
48315	48315BL	12V	35W	P222s	-	3
48321	48321BL	12V	55W		H3	
48351	48351BL	12V	100W		-	
48381	48381BL	12V	130W		-	
48700	48700BL	24V	70W		H3	
48731	48731BL	24V	100W		-	

AUTOMOTIVE GLOBES

H3 PERFORMANCE GLOBES

MR FILTER REF. 30	GLASS PART NO.	VOLT	WATTS	BASETYPE	MR FILTER 30	FIG. NO.
-	48471BL	12V	55W	P222s INTENSE PLUS 30	-	3

H3C HALOGEN GLOBES



ORDER PART NO.	GLASS PART NO.	VOLT	WATTS	BASETYPE	MR FILTER 30	FIG. NO.
48323	48323BL	12V	55W	P224/5	-	4

H4 HALOGEN GLOBES

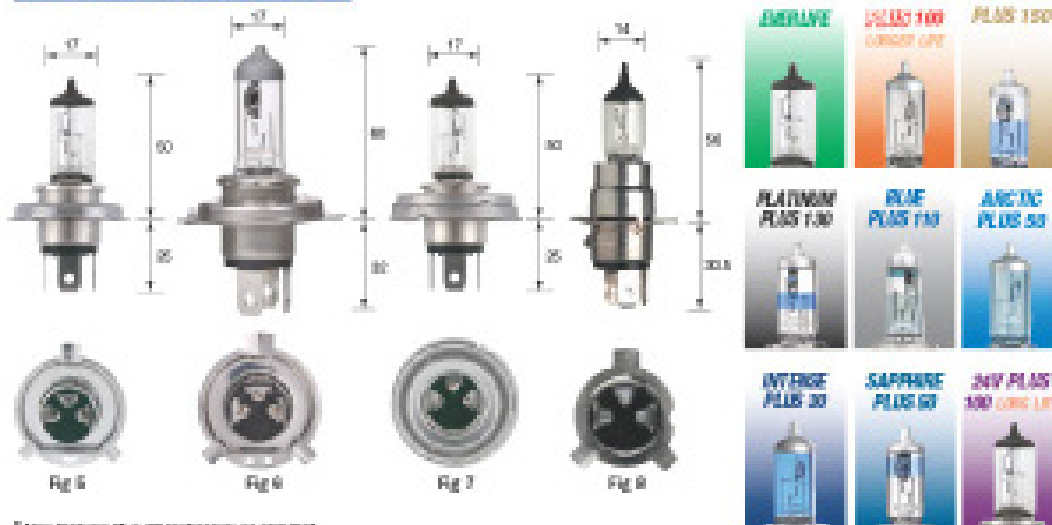

* Main features PLUS 30 technology as standard

BOSS PART NO.	GENERIC PART NO.	VOLT	WATT	BASE/TYPE	AMBIENT CT	FIG NO.
48881 [†]	48881BL [†]	12V	60/55W	P43t Plus 30	H4	
48888	48888BL	12V	60/55W	P43t Heavy Duty	H4	
48889	48889BL	12V	60/55W	P43t EverLife	H4	
48901	48901BL	12V	100/90W	P43t	-	
48911	48911BL	12V	100/55W	P43t	-	5
48951	48951BL	12V	130/100W	P43t	-	
48892	48892BL	24V	75/70W	P43t	H4	
48893	-	24V	75/70W	P43t Heavy Duty	H4	
48895	48895BL	24V	100/90W	P43t	-	
48036	48036BL	12V	25/35W	PM43t	H5L	6
48884	48884BL	12V	60/55W		H4	
48904	48904BL	12V	100/90W		-	7
48894	48894BL	24V	75/70W	P43t (R2)	-	
48994	48994BL	24V	100/90W		-	
48822	-	12V	65/55W	702K	-	8

H4 PERFORMANCE GLOBES

UPDATE PACK (2)	GENERIC PART NO.	VOLT	WATT	BASE/TYPE	AMBIENT CT	FIG NO.
48889BL2 ^{**}	48889BL	12V	60/55W	P43t EWERLIFE		
48872BL2 ^{**}	48872BL	12V	60/55W	P43t PLUS 100 longer life		
48382BL2 [*]	48382BL	12V	60/55W	P43t PLUS 150		
48542BL2 [*]	48542BL	12V	60/55W	P43t PLATINUM PLUS 100	H4	5
48532BL2 [*]	48532BL	12V	60/55W	P43t BLUE PLUS 110		
48677BL2 [*]	48677BL	12V	60/55W	P43t ARCTIC PLUS 50		
48472BL2 [*]	48472BL	12V	60/55W	P43t INTENSE PLUS 30		
48522BL2 [*]	48522BL	12V	60/55W	P43t SAPPHIRE PLUS 50		
48874BL2	48874BL	24V	75/70W	P43t 24V PLUS 100 longer life		

* Pack includes two halogen globes and two 12V SW T-10mm Arctic Blue performance lamp globes

** Pack includes two halogen globes and two 12V SW T-10mm Long Life performance lamp globes

HB3 & HB3A HALOGEN GLOBES

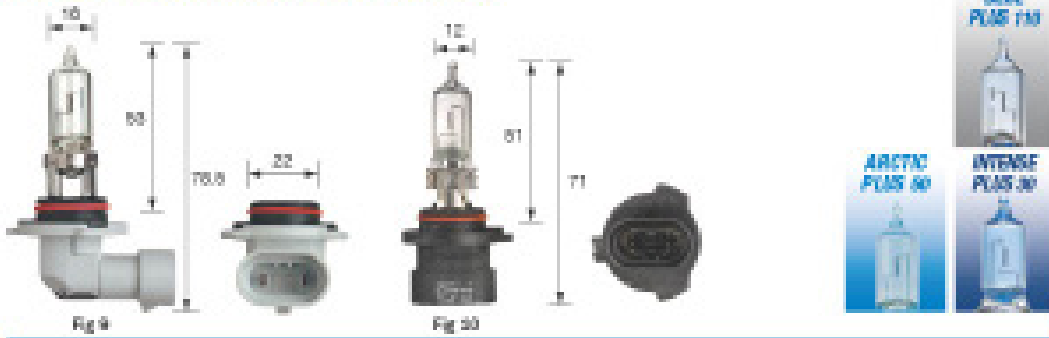

ORDER PART NO.	DISCONTINUED PART NO.	VOLT	WATTS	BASE TYPE	480 SERIES 30	PK. NO.
48005	48005BL	12V	60W	P204 (9005)	HB3	9
48025	48025BL	12V	100W	-	-	-
48020	-	12V	60W	P204 (9005)	HB3A	10

HB3 PERFORMANCE GLOBES

UPGRADE PKG. QTY	DISCONTINUED PART NO.	VOLT	WATTS	BASE TYPE	480 SERIES 30	PK. NO.	
2	48533BL2*	12V	60W	P204	BLUE PLUS 110	HB3	9
2	48616BL2*	12V	60W	P204	ARCTIC PLUS 50		
2	48473BL2*	12V	60W	P204	INTENSE PLUS 30		

* Pack includes two halogen globes and two 12V 5W T-1-Lumen Arctic Blue peak lamp globes

HB4 & HB4A HALOGEN GLOBES

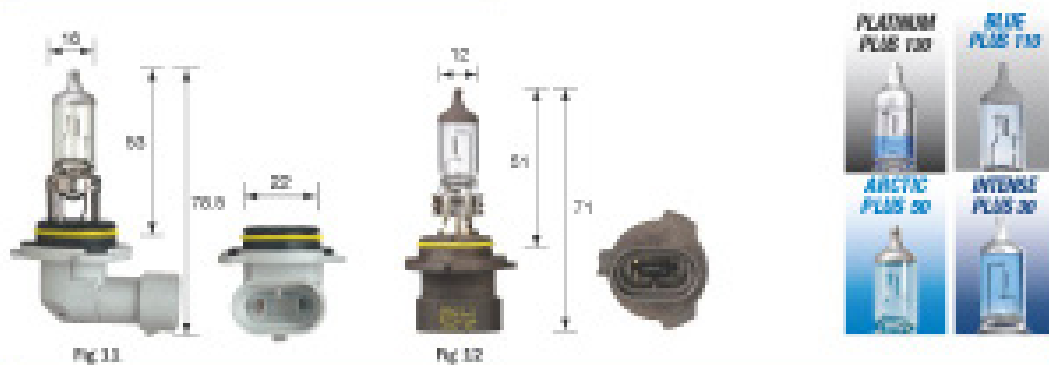

ORDER PART NO.	DISCONTINUED PART NO.	VOLT	WATTS	BASE TYPE	480 SERIES 30	PK. NO.
48006	48006BL	12V	51W	P224 (9006)	HB4	11
48022	48022BL	12V	51W	P224 (9006)	HB4A	12

HB4 PERFORMANCE GLOBES

UPGRADE PKG. QTY	DISCONTINUED PART NO.	VOLT	WATTS	BASE TYPE	480 SERIES 30	PK. NO.	
2	48544BL2*	12V	51W	P224	PLATINUM PLUS 100	HB4	11
2	48534BL2*	12V	51W	P224	BLUE PLUS 110		
2	48613BL2*	12V	51W	P224	ARCTIC PLUS 50		
2	48474BL2*	12V	51W	P224	INTENSE PLUS 30		

* Pack includes two halogen globes and two 12V 5W T-1-Lumen Arctic Blue peak lamp globes

AUTOMOTIVE GLOBES

HB5 HALOGEN GLOBES



Fig 13

OSRAM PART NO.	BUSTERO PART NO.	VOLT	WATT	BASETYPE	AMP SELEC. IT	FIG. NO.
48007	-	12V	65/55W	P120c	HB5	13

AUTOMOTIVE GLOBES

H7 HALOGEN GLOBES

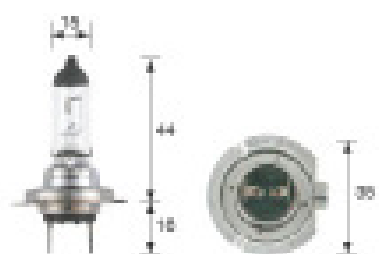

Fig 14



† New feature Plus 50 technology as standard

OSRAM PART NO.	BUSTERO PART NO.	VOLT	WATT	BASETYPE	AMP SELEC. IT	FIG. NO.
48328†	48328BL†	12V	55W	P120d Plus 30	H7	14
48329	48329BL	12V	55W	P120d EverLife	H7	
48330	48330BL	12V	55W	P120d Heavy Duty	H7	
48358	48358BL	12V	80W	P120d	-	
48728	48728BL	24V	70W	P120d	H7	
48729	-	24V	70W	P120d Heavy Duty	H7	

H7 PERFORMANCE GLOBES

OSRAM PART NO.	BUSTERO PART NO.	VOLT	WATT	BASETYPE	AMP SELEC. IT	FIG. NO.
48329BL2**	48329BL	12V	55W	P120d EVERLIFE	H7	14
48339BL2**	48339BL	12V	55W	P120d PLUS 100 Long Life		
48390BL2†	48390BL	12V	55W	P120d PLUS 150		
48545BL2†	48545BL	12V	55W	P120d PLATINUM PLUS 130		
48535BL2†	48535BL	12V	55W	P120d BLUE PLUS 110		
48607BL2†	48607BL	12V	55W	P120d ARCTIC PLUS 50		
48476BL2†	48476BL	12V	55W	P120d INTENSE PLUS 30		
48525BL2†	48525BL	12V	55W	P120d SAPPHIRE PLUS 50		
48730BL2	48730BL	24V	70W	P120d 24V PLUS 100 Long Life		

* Pack includes two halogen globes and two 12V 55W T-Lines Arctic Blue pack lamp globes

** Pack includes two halogen globes and two 12V 55W T-Lines Long Life pack lamp globes

H8/H9/H10 HALOGEN GLOBES

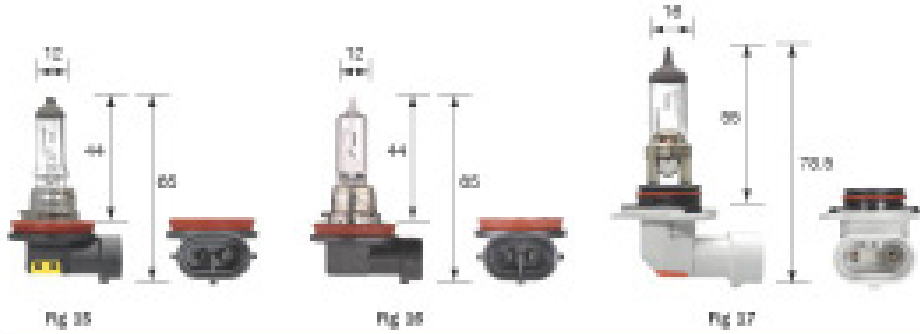

ORDER PART NO.	EXTENDED PART NO.	VOLT	WATTS	BASIS TYPE	ADR SLUCE 37	PG NO.
48076	48076BL	12V	35W	PG119-1	H8	15
48077	48077BL	12V	55W	PG119-2	H8	16
48095	48095BL	12V	42W	PG204	H10	17

H11 HALOGEN GLOBES

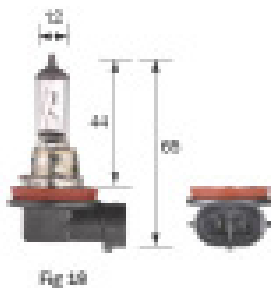

ORDER PART NO.	EXTENDED PART NO.	VOLT	WATTS	BASIS TYPE	ADR SLUCE 37	PG NO.
48078	48078BL	12V	55W	PG119-2	H11	18
48079	48079BL	12V	55W	PG119-2 EverLife		
48080	-	24V	70W	PG119-2		

H11 PERFORMANCE GLOBES

ORDER PART NO.	EXTENDED PART NO.	VOLT	WATTS	BASIS TYPE	ADR SLUCE 37	PG NO.
48079BL2*	48079BL	12V	55W	PG119-2 EVERLIFE	H11	18
48548BL2*	48548BL	12V	55W	PG119-2 PLATINUM PLUS 130		
48538BL2*	48538BL	12V	55W	PG119-2 BLUE PLUS 110		
48478BL2*	48478BL	12V	55W	PG119-2 INTENSE PLUS 39		
48528BL2*	48528BL	12V	55W	PG119-2 SAPPHIRE PLUS 50		
48740BL2	48740BL	24V	70W	PG119-2 24V PLUS 100 Long Life		

* Pack includes two halogen globes and two 12V 5W T-10mm Arcs One pack lamp globes
 ** Pack includes two halogen globes and two 12V 5W T-10mm Long Life pack lamp globes

AUTOMOTIVE GLOBES

H13/H15 HALOGEN GLOBES

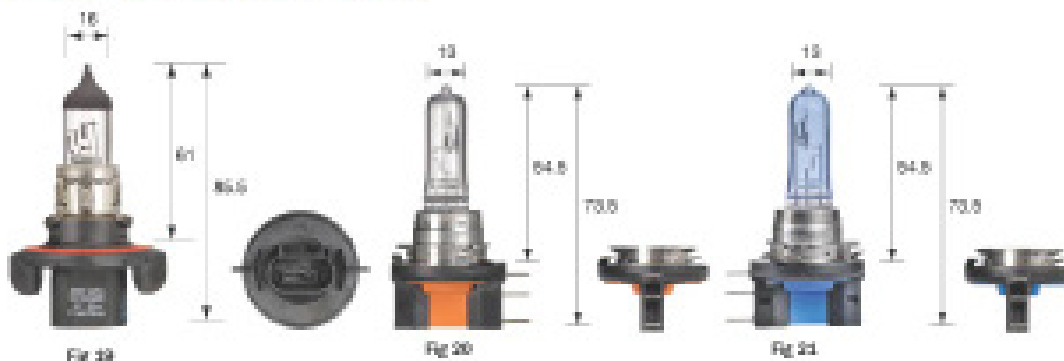

BOSS PART NO.	BUYER'S PART NO.	VOLT	WATT	BASE TYPE	ASH SAE/JE 37	PG NO.
48092	-	12V	60/55W	P25-46	H13	19
48094	48094BL	12V	15/55W	PG1234-1	H15	20
-	48094BL	12V	15/55W	PG1234-1 WYENSE PLUS 30	H15	21

H16/H18/H19 HALOGEN GLOBES



BOSS PART NO.	BUYER'S PART NO.	VOLT	WATT	BASE TYPE	ASH SAE/JE 37	PG NO.
48098	48098BL	12V	19W	PG119-3	H16	23
48018	-	12V	65W	PY36D-1	H18	23
48019	-	12V	60/55W	PU43T-3	H19	24

H27 HALOGEN GLOBES



BOSS PART NO.	BUYER'S PART NO.	VOLT	WATT	BASE TYPE	ASH SAE/JE 37	PG NO.
48042	48042BL	12V	27W	PG113	H27W2	25
48046	-	12V	27W	PG113	-	26
48052	48052BL	12V	37.5W	PG113	-	25

HIR1/HIR2 GLOBES



ORDER PART NO.	DESCRIBED PART NO.	VOLT	WATTS	BASE TYPE	REF NO.	MR FILTER PT	FIG NO.
48062	48062BBL	12V	65W	P3204	9011	HIR1	27
48060	48060BBL	12V	65W	P3204	9012	HIR2	28

ASYMMETRICAL HEADLAMP GLOBES



ORDER PART NO.	DESCRIBED PART NO.	VOLT	WATTS	BASE TYPE	MR FILTER PT	FIG NO.
49211	-	12V	45/40W	P45x41 (P3)	-	29
49212	-	12V	50/40W	P234 (T38)	-	30

MINIATURE HALOGEN GLOBES

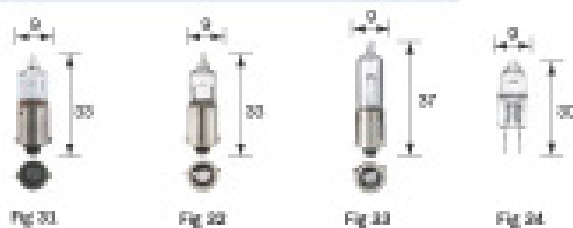

ORDER PART NO.	DESCRIBED PART NO.	VOLT	WATTS	BASE	REF NO.	MR FILTER PT	FIG NO.
17830	-	12V	5W		YL125	H5W	
17833	-	12V	10W	B45s	-	H10W	31
17836	-	12V	20W		YL220	H20W	
68161	-	12V	6W	B40s	-	H6W	32
68191	-	12V	21W	B40s	-	H21W	33
68196	-	24V	21W	B40s	-	H21W	33
68613	68613BBL	12V	10W	G4	YML210	-	34
68621	68621BBL	12V	20W	G4	YML220	-	34

MR FILTER 2019/20 DATASHEET | 167

AUTOMOTIVE GLOBES

GLOBE HOLDERS

PART NO. / DESCRIPTION

49806

Wedge Base Globe Holder

Suits T-10mm and T-15mm wedge globes
 Fixture type: Twist lock
 Packed per 10



49808

Wedge Base Globe Holder

Suits T-10mm wedge globes
 Fixture type: Grommet
 Hole dia. 15mm
 Individually packed



49809

Wedge Base Globe Holder

Suits T-10mm wedge globes
 Fixture type: Push fit
 Hole dia. 12mm
 Individually packed

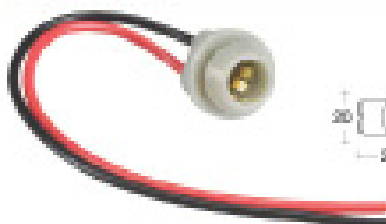

49810

Wedge Base Globe Holder

Suits T-10mm wedge globes
 Fixture type: Push fit, low profile suits closed headlamp bezels
 Hole dia. 14mm
 Individually packed

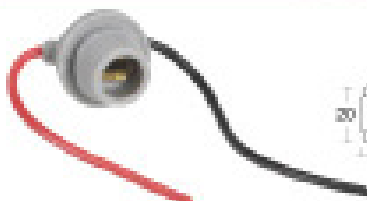

49812

Wedge Base Globe Holder

Suits T-10mm wedge globe
 Fixture type: Twist lock
 Individually packed



4981288 - Glass Pack

49814

Bayonet Base Globe Holder

Suits BA06 globes
 Fixture type: Grommet
 Individually packed



49818

Bayonet Cap Globe Holder

Suits BA06 globes
 Fixture type: Push lock
 Hole dia. 16mm
 Individually packed



AUTOMOTIVE GLOBES

GLOBE HOLDERS

AUTOMOTIVE GLOBES

PART NO. / DESCRIPTION

49826

Bayonet Cap Globe Holder

Suits BR15s globes
 Fixture type: Twist lock
 Individually packed

49826BL - Blister Pack

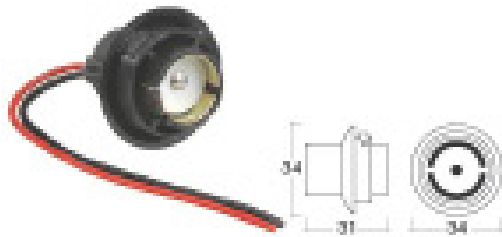

49828

Bayonet Cap Globe Holder

Suits BR15s globes
 Fixture type: Push lock
 Hole dia. 28.5mm
 Individually packed

49828BL - Blister Pack

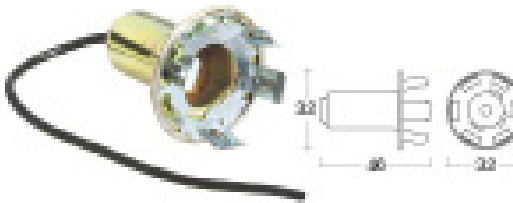

49830

Bayonet Cap Globe Holder

Suits BR15s globes
 Fixture type: Push lock with optional mounting bracket
 Hole dia. 18mm
 Individually packed

49830BL - Blister Pack



49836

Bayonet Cap Globe Holder

Suits BR15d globes
 Fixture type: Twist lock
 Individually packed

49836BL - Blister Pack

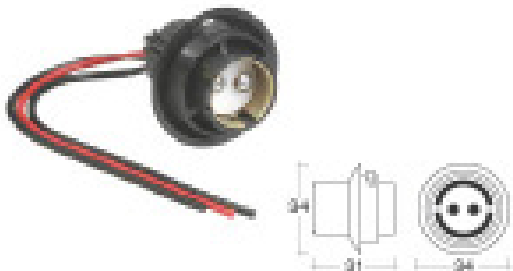

49838

Bayonet Cap Globe Holder

Suits BR15d globes
 Fixture type: Push lock
 Hole dia. 28.5mm
 Individually packed

49838BL - Blister Pack

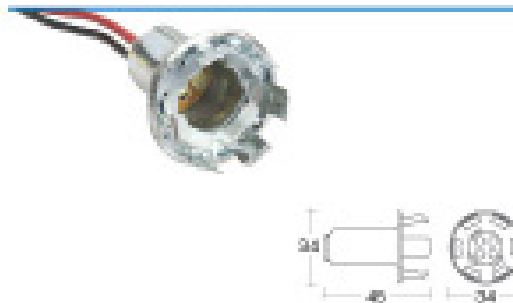

GLOBE HOLDERS

PART NO. / DESCRIPTION

49890

H83 Connector
Suits H83 P204 halogen globe
Individually packed

49890BL - Blister Pack



49892

H84 Connector
Suits H84 P224 halogen globe
Individually packed

49892BL - Blister Pack

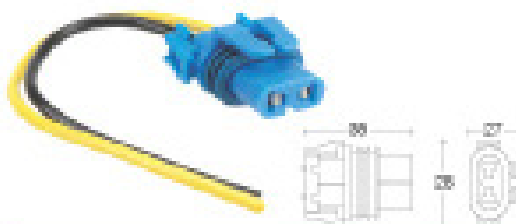

49894

Sealed Beam and H4 Connector

Suits 7", 6W sealed beams and H4 P43 halogen globe
Individually packed

49894BL - Blister Pack

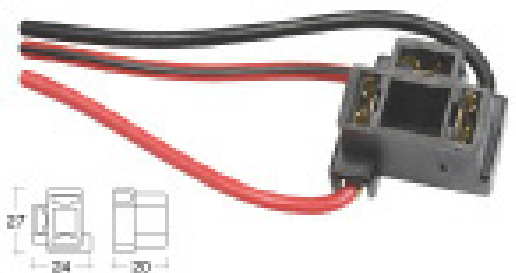

49896

H7 Connector
Suits H7 P226 halogen globe
Individually packed

49896BL - Blister Pack

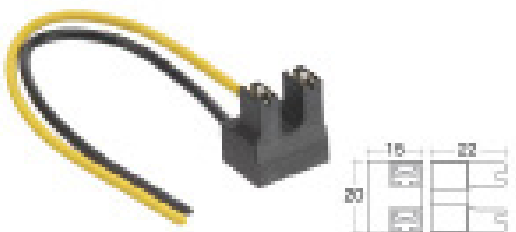

49897

H9 Connector
Suits H9 P6129-S halogen globe
Individually packed

49897BL - Blister Pack

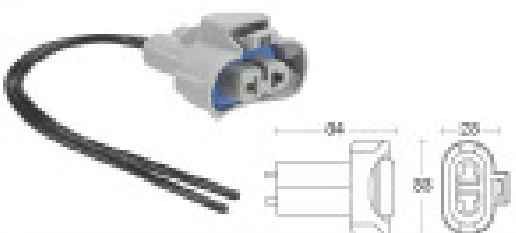

49898

H11 Connector
Suits H11 P6129-2 halogen globe
Individually packed

49898BL - Blister Pack

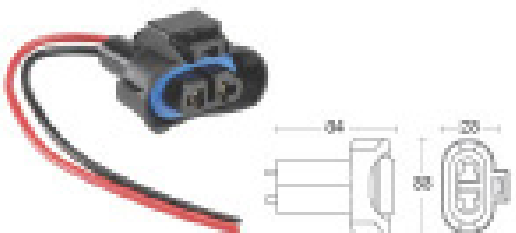

AUTOMOTIVE GLOBES

HAZEL 3019/20 CATALOGUE | 181

WWW.MRFILTER.COM.AU

SYDNEY (02) 9769 1166

Mr Filter EST 1996
TRUCKING EARTHMOVING MINING
SUPPLIES

BRISBANE (07) 5540 7530

Globes, LED & Halogen - LED Globes



Led PCB 24Pc 6W/12V White
100105



36 X Smd Led T10 Wedge White
T10SM36W



LED Festoon 32mm 3W/12V
100111



LED Strip Lamp 12W/12V
100112



LED PCB 3W/12V COB
100115



LED PCB 48 12W/12V DC
100117



Philips Hb3/4 12V Led UI
11005UE2X2



H4 Canbus Module (Pair)
18184



Narva LED Globe (Pair)
18222BL



Narva LED Globe (Pair)
18224BL



12/24V Gen III LED BA15S
18260BL



H4 Surefit GEN 2 LED Globes
18434



H7 Surefit GEN 2 LED Globes
18437



H8/H9/H11 Surefit GEN 2 LED
18438



Led W5W T10 Wedge Globe
990111



HB3 LED Direct Fit Bulb Kit
999005



H7 LED Direct Fit Bulb Kit
999007



H8/9/11/16 LED Direct Fit
999011



LED H4 Headlight Globe
EXH46500K



Led Upgrade Kit H4 9-32V
GL9804

WWW.MRFILTER.COM.AU



Led Upgrade Kit H7 9-32V
GL9807



Led Upgrade Kit H8 H9
GL9808



Led Upgrade Kit H1 9-32V
H1-5000LM



Led Upgrade Kit H3 9-32V
H3-5000LM



Led Upgrade Kit H4 9-32V
H4-5000LM



Packet 2 Led Canbus Module
H4CANBUS



Led Upgrade Kit H7 9-32V
H7-5000LM



Packet 2 Led Canbus Module
H7CANBUS



Led Upgrade Kit H8 H9
H8911-5000LM



Ignite H1 Led Retrofit Headlight
IGL9801



Ignite H3 Led Retrofit Headlight
IGL9803



Pkt 2 H4 Led Retro Fit Globe
IGL9804



Pkt 2 H7 Led Retro Fit Globe
IGL9807



H27 Led Retrofit Globe Pair
IGL9880



Bayonet 12v 4W BA9S 6000K
LEDB242



Bayonet 10-30v 21w BA15S
LEDB264



Bayonet 12v 21w BAU15s
LEDB264FY



Bayonet 10-30v 21/4w
LEDB265



Bayonet 10-30v 21/5w
LEDB265D



Festoon 12v 10w SV8.5 T11
LEDF271

WWW.MRFILTER.COM.AU

SYDNEY (02) 9769 1166

Mr Filter EST 1996
TRUCKING EARTHMOVING MINING
SUPPLIES

BRISBANE (07) 5540 7530



Festoon 12v 10w SV8.5 T11 6000K (2PK)
LEDF272A



Festoon 12v 10w SV8.5 T11 6000K
LEDF274



Resistor 25w (2PK)
LEDRESIST



Wedge 12v W5W T10 6000K
LEDW252



Wedge 10-30v 21/5w T20
LEDW3157



Wedge 10-30v 21w T20 6000K
LEDW920



Wedge 10-30v 21w T20
LEDW920A



Wedge 10-30v 16w T15/T16
LEDW921



Wedge 10-30v 21/5w T20
LEDW922

Light Bars & Driving Lights - Driving Lights



LED Driving Lamp 180 Ultima
71730



LED Driving Lamp 215 LED
71740



Ultima 215 Mk2 Driving Light Kit
71742BK



Driving Lights 185w (pair)
DRL185



7" Led Driving Lamp Spot Beam
LS9571



LED Driving Light 6" DL Series
RDL4600S



LED Driving Light 6" DL2 Series
RDL4601S



LED Driving Light 7" DL Series
RDL4700S

WWW.MRFILTER.COM.AU



LED Driving Light 7" DL2 Series
RDL4701S



LED Driving Light 9" DL Series
RDL4900S



LED Driving Light 9" DL2 Series
RDL4901S



Led Driving Light Set Dle Series 7"
RDLW1700S



7In Hi/L0/Drl Headlight
72104



Light Cover To Suit 1345
8132



Light Cover To Suit 1308
8137



Lens Protector To Suit 72250, 72260
72204BL



Lightforce Yellow Lens Filter - Flood
F210WY



Yellow Lens Filter - Combo
FYBWD



Halogen Driving Light Round 12V
72210



Semi Sealed Beam H4 200x142mm
ISB2004



Hella Comet 500 Series Amber
1108



Round Sealed Beam Head Lamp
5001X



Headlight Left Hand 24V 55W
6000X



240Mm Replacement Reflector
REFH240



Round Seald Beam 5 3/4" 37.5Watt
SB5337



Hella Headlight Body T/S Semi / Sealed
1016



Front Park Lamp Left Hand
11R0711



Headlamp - R/H - Manual
3097294-2

WWW.MRFILTER.COM.AU

SYDNEY (02) 9769 1166

Mr Filter EST 1998
TRUCKING EARTHMOVING MINING
SUPPLIES

BRISBANE (07) 5540 7530



Headlight / Clearance Right Hand
3R0744



Headlight Semi Sealed Beam
3R0745



Lamp Park / Clearance Right Hand
3R0753



Front Parking Headlight Lamp
3R0754



Front Parking Lamp
4R0702



Semi Sealed Beam Rectangle
62-97003



Revolution Sealed Beam High/Low
62-99960



Halogen Head Light Round 90mm
71984



Semi Sealed Beam Round 178mm
72000



Halogen Headlamp - H4 5 (146mm)
72008



Semi Sealed Beam Round 146mm
72010



Semi Sealed Beam Round 146mm
72012



Round Semi Sealed Beam 7" H4
SB7004



Housing To Suit 72046, 72048, 72050
72186



12v Driving Light & Light Bar Harness
74401



Round Seald Beam 5 3/4"
ISB5337



Round Semi Sealed Beam 7"
ISB7004



Semi Sealed H4 Rectangle
LLX97003



Sealed Beam High/Low 12V
LLX99997



Round Semi Sealed Beam 7"
LS1058

WWW.MRFILTER.COM.AU



Driving Light Wiring Harness
RDWK



Semi Sealed Beam 7" Round
RG2500PK



Semi Sealed Beam - 7" Square
RG2501



5-3/4" Semi Sealed
RG2502



5-3/4" Head Light High Beam
RG2503



Semi Sealed Beam - 6" Square
RG2504



Semi Sealed Beam - 5" Square
RG2505



Headlamp Sealed Beam 24V
SB6001

Light Bars & Driving Lights - Light Bars



LED Light Bar 12 X 5W 900 Lumen
72735



LED Light Bar 36 x 5W 650 Lumen
72766



Light Bar Double Row 40 X 5W LED
72772



24 Led Dual Row Driving Lightbar
HU9609



54 Led Dual Row Driving Lightbar
HU9612



LED Bar Light 40" SR2 Series
RBL1400C



LED Bar Light 30" Rollar Series
RBL230C



LED Bar Light 22" DC2 Series
RBL5220C



LED Bar Light 10" SRW Series
RBWL110S



32" Deluxe Lightbar + 3" Work Lights
SC-CO-AKDOM32-3WORK



18 Led Driving Lamp Lightbar
HU9604



Hella Magnetic Mounting Bracket
9-1537-08

WWW.MRFILTER.COM.AU

SYDNEY (02) 9769 1166

Mr Filter
EST 1996
TRUCKING EARTHMOVING MINING
SUPPLIES

BRISBANE (07) 5540 7530

Mechanical Testing Equipment - Battery Testers



Digital Battery Tester
1194TQ



Battery & Alternator Tester
38050



Kinchrome Battery Load Tester
KP1460



LED Alternator/Battery Current Tester
P1957



Battery Load Tester 6-12V
RG5186



Battery Load Tester
SP61009



Battery Analyzer
SP61060



Deluxe Battery Analyser
SP61062

Mechanical Testing Equipment - Circuit Testers



Hd Extra Long Circuit Tester
20072



No.3000 - Circuit Tester
3000



No.3002 - Super-Duty Circuit Tester
3002



No.3007 - Long Probe Circuit Tester
3007TE



No.3008 - Circuit Tester (0 To 600 V)
3008



Digital LCD Circuit Tester 6 - 24 Volt
3012



10-55 Volt Digital LCD Circuit Tester
3014



No.3015 - Digital LCD Circuit Tester
3015



Circuit Tester Computer Safe LED
302014



Digital LED Circuit Tester
ET3428



Circuit Tester Audible Buzzer
HCTAUD



Hansa Circuit Tester - Lcd Display
HCTLCD

WWW.MRFILTER.COM.AU

SYDNEY (02) 9769 1166

Mr Filter EST 1994
TRUCKING EARTHMOVING MINING SUPPLIES

BRISBANE (07) 5540 7530



Hansa Circuit Tester - Lcd Display 48V
HCTLCD48



Circuit Tester 6-24Volt
SP61011



Circuit Tester 3-48Volt
SP61012



Circuit Tester Long Probe 6-24V
SP61014



Circuit Tester 12V And 42V
SP61015



Voltage Tester Computer-Safe Led
SP61020



Circuit Tester 6-24V Heavy Duty
SP61021



Voltage Tester Dualite Hi/Low
SP61022



Digital Auto Ranging Circuit Tester
SP61024



Pocket Circuit Tester 6-24Volt
T861010

Mechanical Testing Equipment - Multimeters



Multi Meter Tradequip
1256



Carrying Case (DA810 & DA830)
DA014



Digital Automotive Multimeter & Analyzer
DA400



Auto Ranging Multimeter
ET2301B



Auto-Manual Ranging Multimeter
ET2301D



Auto Ranging Multimeter With Dial
ET2301R



Digital Multimeter -114 -600V
FLU114



Multimeter Test Leads Set
MMLSP

WWW.MRFILTER.COM.AU

SYDNEY (02) 9769 1166

Mr Filter EST 1996
TRUCKING EARTHMOVING MINING
SUPPLIES

BRISBANE (07) 5540 7530



Digital Automotive Multimeter
SP62010



Digital Automotive Multimeter
SP62011



Electrical Digital Multimeter
SP62012



Digital Multimeter - Pocket Size
SP62015



EVA Deluxe Digital Multimeter
SP62016



114/APAC Electrical Multimeter
W184171

Mechanical Testing Equipment - OBD Scanner



OBD2 Code Reader
ET2707



OBD Reader for OBD2 and CAN
PT60504



Can Obdii/Eobd Code Reader
SP61150



Can Obdii/Eobd/Jobd Code Reader
SP61155

Mechanical Testing Equipment - Other Testers



9Mm Digital Inspection Camera
1196



Insulation Resistance Tester
1507



12V Thermo Camera Bosch
194048



Digital Multi Tester
20235



Digital Infrared Thermometer
29417



6Pc. Deluxe Noid Light Set
3210



Deluxe Noid - Light & lac Signal Light
3220



Clamp Meter 400A
323

WWW.MRFILTER.COM.AU



Spark Plug Lead Tester
3338



Professional 120mm Wall Detector
5660262



Brake Fluid Tester
6512D



Electronic Ignition Spark Tester
7230



Process Meter
789



60m Laser Distance Measurer
W125351



Infrared Thermometer
AC-IT700



Laser Tachometer
AC-LT900



Magnetic Digital Angle Finder
AFB-15



Electrical Universal Test Lead Set
C2031



Digital Photo, Contact, Surface Tachometer
DT2858



Alkaline Laser Temperature Gun
W118443



WiFi Borescope 5.5mm
ET0914



Refractometer Automotive
ET5672



Thermometer Infrared HVAL
FLU561



Digital Advance Timing Light
MA510



PH 22 LAQUAtwin Compact pH
PH22



Refractometer Hand Held
SP61005



9 Volt Memory Power Supply
SP61054



Charger Battery Pulse 6 Amp 8 Stage
SP61080

WWW.MRFILTER.COM.AU

SYDNEY (02) 9769 1166

Mr Filter EST 1996
TRUCKING EARTHMOVING MINING
SUPPLIES

BRISBANE (07) 5540 7530



EVA Digital Insulation Tester
SP62018



Infrared Laser Guided Thermometer
SP62020



Mini-Infrared Thermometer
SP62022



Tachometer Laser Actuated
SP62030



Non-Contact Digital Tachometer
SP62032



Adjustable Advance Pro Timing Light
SP62040



Digital Professional Timing Light
SP62042



6Mm Camera Delux High Res Borescope
SP70935



Noid Light Set 6Pce
SP71050



Combustion Emission Analyser
TESTO340



Digi-Temp Reversible Thermometer
TLC25-100C

Specialised - Brake Controller



Guardian Brake Controller 12V
05650



Electric Brake Controller 12V
EB



Elite Brake Controller 12/24V
EBRH-ACCV3



Electric Brake Controller 12V
EBTM



Hand Brake Alarm Continuous Tone 12/24V
HBA1224

WWW.MRFILTER.COM.AU

Specialised - Electrical Sensors



Coolant Sensor
TCS133



Sensor Prestolite 5MT2005
104103



Water Temperature Sender
320093



Pressure Sender 1/8 npt
360-019



Sensor Prestolite 89mm
5MT2004



Sensor Prestolite 68mm
5MT2005



Sensor Prestolite 89mm
5MT2032



Turck Inductive Barrel-Style
837-5611



Air Temperature Sensor
9C1112A69AC



Oxygen/Lambda Sensor
EGO329



Heavy Duty Tyre Pressure
EK215H6



Kane 4 Gas Analyser
ET9800



Solar External Tyre Pressure Monitoring
TPS9



Internal Tyre Pressure Monitoring
TPS9I



Inductive Proximity Npn Sensor
LJ18A3-8-Z-BX



Disc Pad Wear Sensor Electric
GIC243P



Hall Effect Current Sensor 8V
GS-AMPS

WWW.MRFILTER.COM.AU

SYDNEY (02) 9769 1166

Mr Filter EST 1996
TRUCKING EARTHMOVING MINING
SUPPLIES

BRISBANE (07) 5540 7530

Specialised - Fuel Pump



Facet Cube Solid State Fuel Pump
40151N



Facet Cube Solid State Fuel Pump
fep12sv



Facet Fuel Pump 24V Solid
FFP311



AFI Electric External Fuel Pump
FP2093-KIT



Fuel Pump - Tank Pressure 0.63kg/cm2
FPX009BL



Fuel Pump - Tank Pressure 0.42kg/cm2
FPX010

Specialised - Inverters & Voltage Reducers



Voltage Regulator
129150-77712



Voltage Reg 12V Bosch
151002



12V 21 Watt Led Load Resistor
90034BL



12v - 5 w Load Resistor
90038BL



12v - 240v Pure Sine Wave Inverter
HU6580



12V 1000W Modified Sine Wave Inverter
IM1000



12V 2000W Modified Sine Wave Inverter
IM2000



Voltage Inverter Pure Sine Wave 12V DC
IP1000



Packet 2 Load Resistor 12V
LR0012



Led 12V Load Resistor Blister Twin
LR122



Led 24V Load Resistor
LR24



240v AC Transformer 12v 3amp
LS9769

WWW.MRFILTER.COM.AU



24 - 12V DC-DC Converter
MP3063



Victron 24v-12v Voltage Reducer
ORI241220200R



Orion 24/12-25 DC-DC Converter
ORI241225020



Switch Mode Voltage Reducer
P5027M



5 Amp Dc-Dc Converter 24/12V
PC2105



10 Amp Dc-Dc Converter
PC2110



Connector Harness And Plug
PK1073



Voltage Converter - 24-12volt
VC10S



Voltage Reducer 24V-12V
SM107



Voltage Reducer 10A
SVC241210



Prime Redvision System Kit
TVMSKIT05



2 Amp Switch Mode Voltage Converter
VC2S



Voltage Reducer 20Amp
VRLREV



Voltage Reducer 10Amp
VRMREV

Specialised - Meter Gauges



Hour Meter Rectangle Analogue
331-534



Vdo Hour Meter Digital Resettable
331-535LCD



VDO 12V Analogue Hour Meter
331032001



VDO Hour Meter Analogue
331601

WWW.MRFILTER.COM.AU

SYDNEY (02) 9769 1166

Mr Filter EST 1998
TRUCKING EARTHMOVING MINING
SUPPLIES

BRISBANE (07) 5540 7530



VDO Tachometer
333035011



Hobbs Round Hourmeter
EG1609



Analogue Round Hourmeter
EG1621



Round Digital Lcd Hourmeter
EG1622



Mini Hourmeter 6-50V
EG1623



Electronic Oil Meter - 1/2"
IM012E-01

Specialised - Solar Panels



KT Cables 12V 40W Solar
572271



Redarc Solar Panel 12V
SMR1050



Redarc 180W Mono Solar
SMSP1180



Projecta Amorphous 12V
SPA400



Redarc Solar Regulator
SRP0120



12V 200W Blanket Solar
ZM9124



Powertech 12V 160W
ZM9178



160W Solar Panel Grade 4
ZM9178-4



Arlo Essentials Solar Panel
476787



Arlo Universal Solar V2
511292



Redarc Solar Panel
SMR1150-SL

WWW.MRFILTER.COM.AU

Specialised - Soldering Irons & Resin



Handyman Soldering Torch Kit
211267



Trade Flame Electric Soldering Iron
212012



Soldering Iron 40w
PT42011



Soldering Butane Pencil
PTORCH



Slimline Soldering Iron
HD1938-2



Electric Soldering Iron 30W
HDS30W



Electric Soldering Iron 60W
HDS60W



Electric Soldering Iron 80W
HDS80W



Soldering Iron Gas Torch Kit
HS1115K



Slimline Torch and Soldering Iron
HT1937-2



Micro Torch Kit With Soldering Tips
HT900KIT



Crescent Soldering Iron 25 Watt
N25D



Crescent Soldering Iron 40 Watt
N40D



Crescent Soldering Iron 80 Watt
N80D



Iroda Solderpro 150 Kit
PRO-150K



0.8mm 100g Solder Wire Resin
660355



Acid Core Solder 1.6mm Tin 60/ Lead 40
ACX6155



Solder Wire 100G 2.3MM
RG7669



Solder Acid Core 1.6Mm
SOAC16



Solder Resin Core 1.6Mm
sorc16

WWW.MRFILTER.COM.AU

SYDNEY (02) 9769 1166

Mr Filter
EST 1998
TRUCKING EARTHMOVING MINING
SUPPLIES

BRISBANE (07) 5540 7530



Solder Resin Core 1.6Mm
SORC17



Professional Gas Soldering Kit
SP32290



Li-Ion Cordless Soldering Iron
W129505

Specialised - Solenoids



Irrigation Solenoid Valve Toro
0295437



Kubota Denso Stop solenoid
0526001001



Fuel shutdown Shut Off solenoid
119233-77932



Continuous Duty Solenoid
15-381



Solenoid Shut off Hatz
1811601



Kubota Fuel Shut-Off Solenoid
1A021-60017



Continuous Duty Solenoid
24059BX



Solenoid 24V 200A Continuous Duty
24144BX



Cole Hersee Continuous Duty Solenoid
24213BX



12VDC Solenoid Start Switch
39002136



Parker Solenoid Valve
443782W



Solenoid Continuous Duty
48-912



Solenoid Continuous Duty
48-924



Parker 2-Way Normally Closed, 32MM
481865C2



OEX Continuous Duty Solenoid
ACX3306



OEX Starter Motor Slave Solenoid
ACX3345

WWW.MRFILTER.COM.AU



1" BSP Brass Normally Closed Solenoid
B35-6-20-8N



2" BSP Brass Normally Closed Solenoid
B35-9-50-8N



3/4" BSP Brass Normally Open Solenoid
B36-5-20-8N



Shut Down Solenoid 12V
BSS112912



Shut Down Solenoid 12V
BSS147012



Shut Down Solenoid 12V
BSS149212



Shut Down Solenoid 12V
BSS1493



Shut Down Solenoid 12V
BSS1503ES-12S



Shut Down Solenoid 12V
BSS1504-12



Shut Down Solenoid 12V
BSS1751-12



Shut Down Solenoid 24V
BSS1943



Shut Down Solenoid 12V
BSS2003-12



Engine Shut Off Throttle
EA9910



Engine Throttle Solenoid
EA9911



Engine Throttle Solenoid
EA9921



Engine Shut Off Throttle
ACX3330



OEX Engine Shut Down
ACX3332



Carbon Winches Australia 600Amp
CWA-SOLENOID24V



5/2-way Solenoid Valve
KM10510HN24VDC



SP-COE-24DC/10 Solenoid
SP-COE-24DC10

WWW.MRFILTER.COM.AU

SYDNEY (02) 9769 1166

Mr Filter EST 1999
TRUCKING EARTHMOVING MINING SUPPLIES

BRISBANE (07) 5540 7530



VLV 3/2 1/4 N/C 12VDC 3-Port Solenoid
VT307K-6DZ1-02

Switches, Flashers, Relays & Horns - Circuit Breakers

CIRCUIT BREAKERS

A circuit breaker is an automatically operated electrical device designed to protect an electrical circuit from damage caused by overload or short circuit. Unlike a fuse, which operates once and then has to be replaced, a circuit breaker can be reset (either manually or automatically) to resume normal operation. Automatic units are cycling and continuously self resetting, whilst the manual units are used where investigation of the fault is required prior to the circuit being reset.

The range includes traditional metal or plastic units and heavy-duty high amp units, typically used for transport or marine applications. Also included are plug-in types that can be used as a replacement for standard ATS blade fuses. These units are essentially a blade fuse that doesn't need replacing.

FUSES & FUSE ACCESSORIES

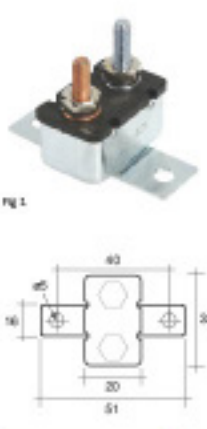

PART NO.	QTY/UNIT	AMPS	TYPE	PRICE
CIRCUIT BREAKERS - AUTOMATIC RESET				
54610	1	10	Metal Circuit Breaker Automatic Reset (Type 1) with 90° Bracket Voltage 6-24V Operating Temperature: -20°C to 65°C	1
54610BL	Blister (1)			
54615	1	15		
54615BL	Blister (1)			
54620	1	20		
54620BL	Blister (1)			
54625	1	25		
54625BL	Blister (1)			
54630	1	30		
54630BL	Blister (1)			
54640	1	40		
54640BL	Blister (1)			
54650	1	50		
54650BL	Blister (1)			

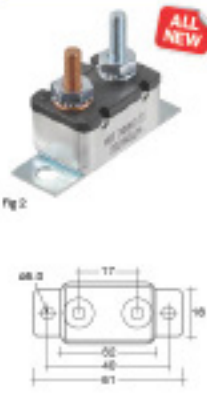

PART NO.	QTY/UNIT	AMPS	TYPE	PRICE
CIRCUIT BREAKERS - AUTOMATIC RESET				
54710	1	10	Metal Circuit Breaker Automatic Reset (Type 1) with Straight Bracket Voltage 6-24V Operating Temperature: -20°C to 65°C	2
54710BL	Blister (1)			
54715	1	15		
54715BL	Blister (1)			
54720	1	20		
54720BL	Blister (1)			
54725	1	25		
54725BL	Blister (1)			
54730	1	30		
54730BL	Blister (1)			
54740	1	40		
54740BL	Blister (1)			
54750	1	50		
54750BL	Blister (1)			

196 | HANNA 2019/20 CATALOGUE

WWW.MRFILTER.COM.AU



CIRCUIT BREAKERS

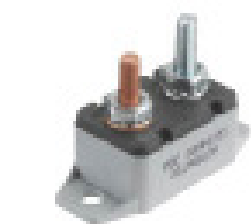

Fig 3

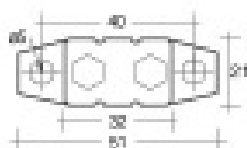

Fig 4

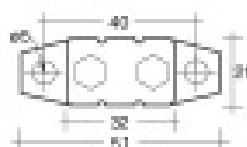
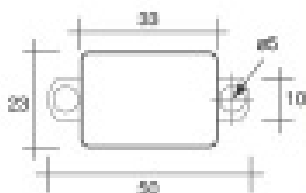

Fig 5



PART NO.	CIRCUIT BREAKER	AMPS	TYPE	PRICE
CIRCUIT BREAKERS - AUTOMATIC RESET				
54810	1	10	Plastic Circuit Breaker Automatic Reset (Type I) with Straight Bracket Voltage: 12-24V Operating Temperature: -20°C to 65°C	3
54815		15		
54820		20		
54830		20		
54840		40		
54850		50		

CIRCUIT BREAKERS - MANUAL RESET				
54915	1	15	Plastic Circuit Breaker Manual Reset (Type III) with Straight Bracket Voltage: 12-24V Operating Temperature: -20°C to 65°C	4
54920		20		
54930		20		
54940		40		
54950		50		

CIRCUIT BREAKERS - SEALED, AUTOMATIC RESET				
55220	1	20	Weatherproof Sealed Circuit Breaker with Straight Bracket Automatic Reset (Type I) Designed for exposed applications. Resistant to moisture, dust, oil, etc. Supplied with 300mm wire loop Voltage: 12V Operating Temperature: -20°C to 65°C	5
55230		20		
55240		40		

FUSES & FUSE ACCESSORIES

MRFA 2019/20 CATALOGUE | 197

WWW.MRFILTER.COM.AU

SYDNEY (02) 9769 1166

Mr Filter EST 1996
TRUCKING EARTHMOVING MINING SUPPLIES

BRISBANE (07) 5540 7530

CIRCUIT BREAKERS

FUSES & FUSE ACCESSORIES



PART NO.	SAFETY FEATURES	AMPS	VOLT	ICD NO.
CIRCUIT BREAKERS - AUTOMATIC RESET				
55610 55610BL	5 Blister (1)	10	Plug-In Circuit Breaker for direct replacement of Standard ATS Blade Fuses. Flame retardant body	6
55615 55615BL	5 Blister (1)	15		
55620 55620BL	5 Blister (1)	20		
55625 55625BL	5 Blister (1)	25		
55630 55630BL	5 Blister (1)	30		
Automatic Reset (Type I) Voltage: 10-32V Operating Temperature: -30°C to 60°C				



PART NO.	SAFETY FEATURES	AMPS	VOLT	ICD NO.
CIRCUIT BREAKERS - MANUAL RESET				
55705 55705BL	5 Blister (1)	5	Plug-In Circuit Breaker for direct replacement of Standard ATS Blade Fuses. Flame retardant body	7
55708 55708BL	5 Blister (1)	8		
55710 55710BL	5 Blister (1)	10		
55715 55715BL	5 Blister (1)	15		
55720 55720BL	5 Blister (1)	20		
55725 55725BL	5 Blister (1)	25	Manual Reset (Type II) Voltage: 10-32V Operating Temperature: -30°C to 60°C	
55730 55730BL	5 Blister (1)	30		

198 | MARVAL 2019/20 CATALOGUE

WWW.MRFILTER.COM.AU

Mr Filter EST 1998
TRUCKING EARTHMOVING MINING SUPPLIES

SYDNEY (02) 9769 1166

BRISBANE (07) 5540 7530

CIRCUIT BREAKERS



Fig 8

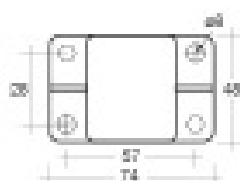

PART NO.	QUANTITY PER PACK	AMPS	TYPE	PAGE NO.
CIRCUIT BREAKERS - HIGH AMP AUTOMATIC				
55950		60	High Amp Circuit Breaker Automatic Reset (Type II) Surface Mount Sealed for engine compartment or marine applications Voltage: 12-42V Operating Temperature: -32°C to 82°C	8
55952		80		
55954	1	300		
55956		120		
55958		150		



Fig 9

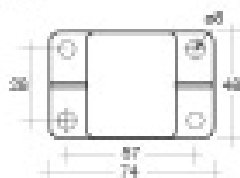

PART NO.	QUANTITY PER PACK	AMPS	TYPE	PAGE NO.
CIRCUIT BREAKERS - HIGH AMP MANUAL				
55960		60	High Amp Circuit Breaker Manual Reset (Type II) Surface Mount Sealed for engine compartment or marine applications with unique reset mechanism providing visible indication of tripped circuit Voltage: 12-42V Operating Temperature: -32°C to 82°C	9
55962		80		
55964	1	300		
55966		120		
55968		150		



Fig 10

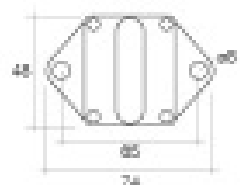

PART NO.	QUANTITY PER PACK	AMPS	TYPE	PAGE NO.
CIRCUIT BREAKERS - HIGH AMP MANUAL RESET				
55970		60	High Amp Circuit Breaker Manual Reset (Type II) Panel Mount Sealed for engine compartment or marine applications with unique reset mechanism providing visible indication of tripped circuit Voltage: 12-42V Operating Temperature: -32°C to 82°C	10
55972		80		
55974	1	300		
55976		120		
55978		150		

FUSES & FUSE ACCESSORIES

Switches, Flashers, Relays & Horns - Flashers

FLASHERS

Narva has a complete range of Flashers manufactured to meet the highest international standards starting with the low cost thermal units through to sophisticated electronic flashers with no load circuitry for use with LED lamps.

There are three basic flasher types: Thermal, Electro-Mechanical and Solid State Electronic. The introduction of both Electro-Mechanical and Electronic Flashers has produced a higher level of reliability, a clearer audible sound and a more consistent flash rate under load and temperature variations. Electronic Flashers were introduced in accordance with the function of "testage" or globe failure as required by the Australian Design Rule, ADW 13. Early electronic units are load sensitive, although new units are now available with minimal to no load requirement for use with LED lamps.

The range incorporates features such as pilot lamp indication, hazard warning and heavy-duty units for B-Double and Road Train applications.

Narva Flashers are marked with the international pin identification system as listed below.

FLASHER CONNECTIONS

L	Lamps or indicator switch	31	Earth (-)
F	Pilot	30b	Hazard switch (+)
3	Battery (+) or Ignition	+	Battery (+) or Ignition
B	Battery (+) or Ignition	-	Earth (-)
E	Earth (-)	0	Vehicle pilot
4b	Battery (+) or Ignition	C2	1st trailer pilot
4ba	Lamps or indicator switch	C3	2nd trailer pilot



SWITCHES, FLASHERS, RELAYS & HORNS

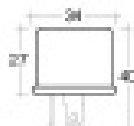

PART No. / DESCRIPTION

68202BL Glass Pack

12 Volt 2 Pin Thermal Flasher

Suitable only for early model indicator and hazard warning systems. Maximum load: 6 x 30CP (24 watt globes)

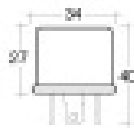
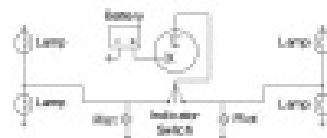

68203BL Glass Pack

12 Volt 3 Pin Thermal Flasher

Suitable only for early model indicator and hazard warning systems. Pilot function

Maximum load: 6 x 30CP (24 watt globes)

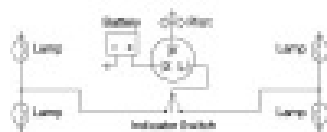

MRFA 3019/00 CATALOGUE | 327

WWW.MRFILTER.COM.AU



SYDNEY (02) 9769 1166

BRISBANE (07) 5540 7530

FLASHERS

SWITCHES, FLASHERS, RELAYS & HORNS

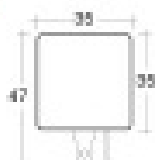

NB: For LED applications use 6841 and 6842, with modification to the leads

PART NO. / DESCRIPTION

68212BL Bicolor Peak

12 Volt 3 Pin Electronic Flasher

Suitable for indicator and hazard warning systems
Non load sensitive type
Maximum load: 10 x 21 watt globes

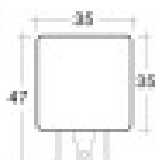
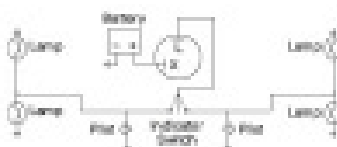

NB: For LED applications use 6841, 68253BL

68213BL Bicolor Peak

12 Volt 3 Pin Electronic Flasher

Suitable for indicator and hazard warning systems
Non load sensitive type
Pilot function
Maximum load: 10 x 21 watt globes

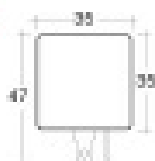

NB: For LED applications use 6841, 68253BL, with modification to the leads

68222BL Bicolor Peak

24 Volt 2 Pin Electronic Flasher

Suitable for indicator and hazard warning systems
Non load sensitive type
Maximum load: 10 x 21 watt globes

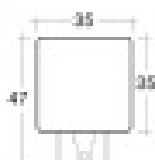
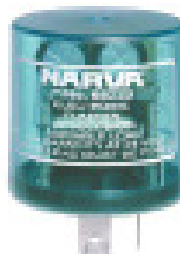
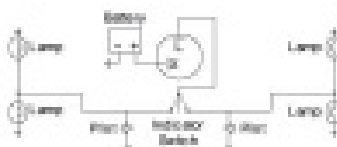

NB: For LED applications use 6841, 68253BL

68223BL Bicolor Peak

24 Volt 3 Pin Electronic Flasher

Suitable for indicator and hazard warning systems
Non load sensitive type
Pilot function
Maximum load: 10 x 21 watt globes

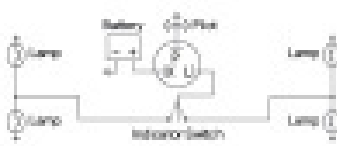

FLASHERS

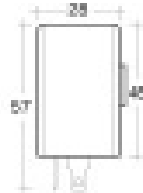

Part No. / DESCRIPTION

68232BL Blister Pack

12 Volt 3 Pin Electronic Flasher

Suitable for indicator and hazard warning systems
Load sensitive type
Globe outage indication
Maximum load: 6 x 31 watt globes + additional 5 watts

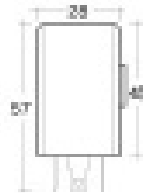
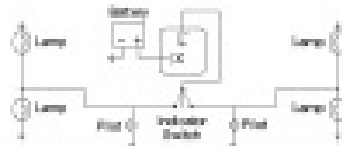

68233BL Blister Pack

12 Volt 3 Pin Electronic Flasher

Suitable for indicator and hazard warning systems
Load sensitive type
Pilot function
Globe outage indication
Maximum load: 6 x 31 watt globes + additional 5 watts

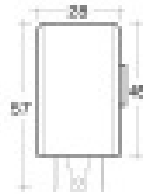
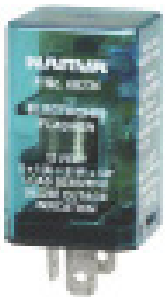
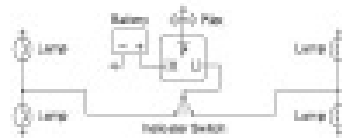

68236BL Blister Pack

12 Volt 3 Pin Electronic Flasher

Suitable for indicator and hazard warning systems
Load sensitive type
Globe outage indication
Maximum load: 6 x 31 watt globes + additional 5 watts

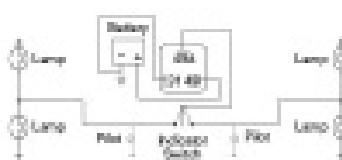

Note: For L.E.O applications see P/Ns. 68245BL

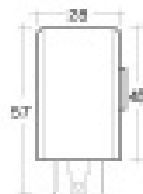

68238BL Blister Pack

12 Volt 3 Pin Electronic Flasher

Suitable for indicator and hazard warning systems
Load sensitive type
Globe outage indication
Maximum load: 6 x 31 watt globes + additional 5 watts

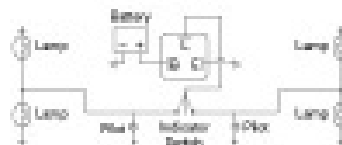

SWITCHES, FLASHERS, RELAYS & HORNS

FLASHERS

SWITCHES, FLASHERS, RELAYS & HORNS

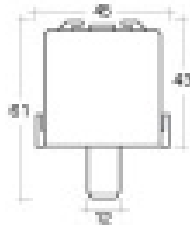

PART NO. / DESCRIPTION

68242BL Bistable Peak

12 Volt 3 Pin Electronic Flasher

Suitable for indicator and hazard warning systems on Japanese manufactured vehicles. Load sensitive type. Globe outage indication. Maximum load: 6 x 21 watt globes + additional 5 watts

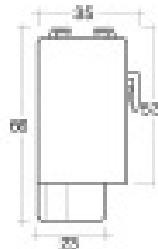

68244BL Bistable Peak

12 Volt 3 Pin Electronic Flasher

Suitable for indicator and hazard warning systems on Japanese manufactured vehicles. Load sensitive type. Globe outage indication. Maximum load: 6 x 21 watt globes + additional 5 watts

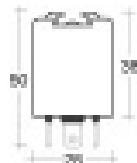

68245BL Bistable Peak

12 Volt 3 Pin Electronic LED Flasher

Suitable for LED indicator lamps. Operates at ultra low current of 1mA (0.02 watts) or higher currents to a maximum of 2.5 amps per side (20 watts) where a mix of LED and incandescent globes might be used

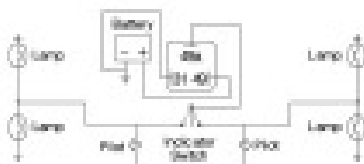

NOTE: Use 11 LED strip apparatus as a direct replacement for P/Ns. 682500L

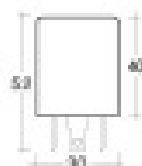
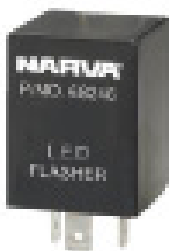

68246BL Bistable Peak

12 Volt 3 Pin LED Flasher

Suitable for truck and trailer applications using a combination of LED lamps and incandescent globes. Load sensitive type. Maximum load: 2 x 21 watt globe and 2 x 9 watt LED lamps



FLASHERS

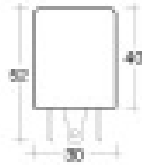

PART NO. / DESCRIPTION

68247BL Bistable Pack
12 Volt 3 Pin **LED** Flasher

Suitable for truck and trailer applications using a combination of LED lamps and incandescent globes. Load sensitive type. Maximum load: 2 x 21 watt globes, 2 x 9 watt LED lamps and 2 x 5 watt globes for side turn indicator.

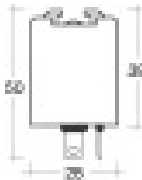
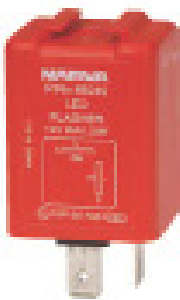
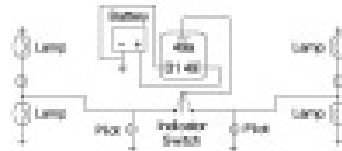

68249BL Bistable Pack
12 Volt 3 Pin Electronic **LED** Flasher

Suitable for use with LED indicator lamps. Operates at ultra low current of 1mA (0.02 watts) or higher currents to a maximum of 2.5 amps per side (20 watts) where a mix of LED and incandescent globes might be used.

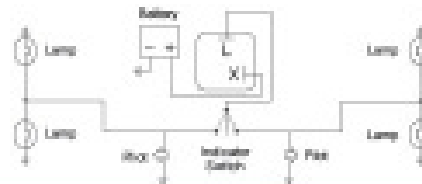

Fit in LED lamp applications as a replacement for P/Ns. 68232BL with modification to the loom.

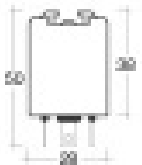

68251BL Bistable Pack
12 Volt 3 Pin **LED** Electronic Flasher with Pilot

Suitable for LED indicator lamps. Operates at ultra low current of 1mA (0.02 watts) or higher currents to a maximum of 2.5 amps per side (20 watts) where a mix of LED and incandescent globes might be used.

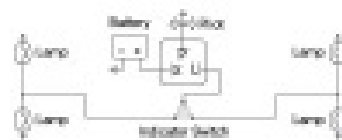

Fit in LED lamp applications as a direct replacement for P/Ns. 68215BL.

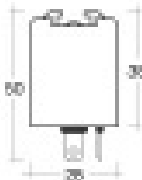
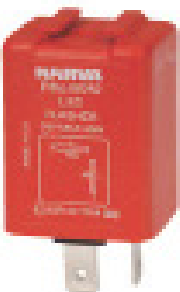

68252BL Bistable Pack
24 Volt 2 Pin **LED** Electronic Flasher

Suitable for LED indicator lamps. Operates at ultra low current of 1mA (0.02 watts) or higher currents to a maximum of 1.5 amps per side (40 watts) where a mix of LED and incandescent globes might be used.

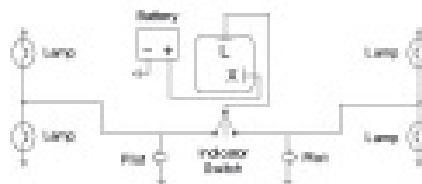

Fit in LED lamp applications as a replacement for P/Ns. 68232BL with modification to the loom.

SWITCHES, FLASHERS, RELAYS & HORNS

FLASHERS

SWITCHES, FLASHERS, RELAYS & HORNS

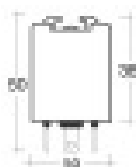
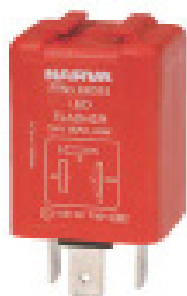

Not use in LED strip applications as a direct replacement for pilot, indicator.

PART NO. / DESCRIPTION

68253BL Bicolor Pack

24 Volt 3 Pin LED Electronic Flasher with Pilot

Suitable for LED indicator lamps. Operates at ultra low current of 1mA (0.02 watts) or higher currents to a maximum of 1.5 amps per side (40 watts) where a mix of LED and incandescent globes might be used

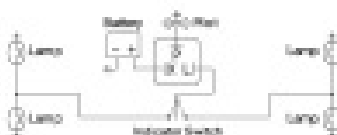

68254BL Bicolor Pack

12 Volt 4 Pin Electronic Flasher

Suitable for caravan or trailer applications including hazard warning systems where an additional pilot circuit on the trailer is required. Load sensitive type. Globe output indication pilot function. Maximum load: 6 x 21 watt globe + additional 5 watts

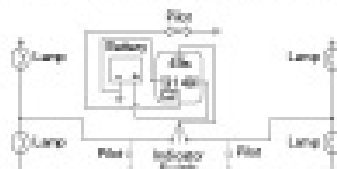
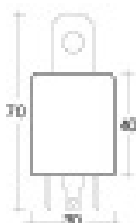

68269BL Bicolor Pack

24 Volt 6 Pin Heavy-Duty Electronic Flasher

A solid state unit suitable for truck and trailer indicator and hazard warning systems where a pilot circuit is required and 3 lamps (per side) are on the vehicle

Load sensitive type

Maximum load: 6 x 21 watt globe

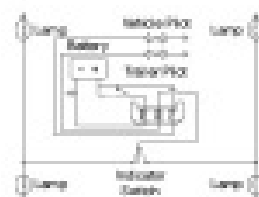
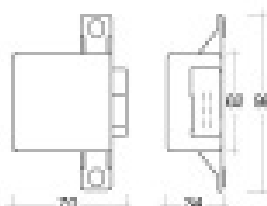

68278BL Bicolor Pack

12 Volt 3 Pin Alternating Flasher

Suitable for emergency vehicles and applications requiring alternating flashing lamps

Not load sensitive type

Maximum load: 10 x 21 watt globe (210W)

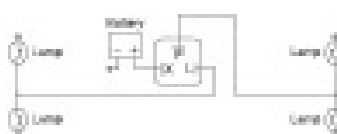
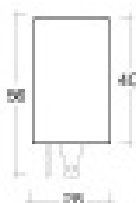

Switches, Flashers, Relays & Horns - Flashers

RELAYS

Relays can be used in a variety of applications where switching of high power is needed, such as auxiliary lighting, heating fans, wipers and air conditioning equipment. Nerve offers a comprehensive range of relays including reverse pin and timer relays.

Nerve relays are manufactured to very exacting original equipment standards under the control of ISO9001. The relays feature silver contacts for durability and a removable metal mounting tab for convenient installation. All relays are rated to 500,000 cycles and feature a braided power strap for increased reliability. Nerve relays are available with resistors or diodes to protect sensitive electronic equipment from voltage spikes. A resistor dampens a voltage spike while allowing the current through, while a diode absorbs the power and stops the spike completely.



- High temperature wire insulation
- Braided strap
- Hard silver contacts
- Resistor or diode protection

RELAY CONNECTIONS

- PIN 30 Power In
- PIN 85 Earth
- PIN 86 Switch
- PIN 87 Power Out ACC1
- PIN 87A Power Out ACC2

SWITCHES, FLASHERS, RELAYS & HORNS

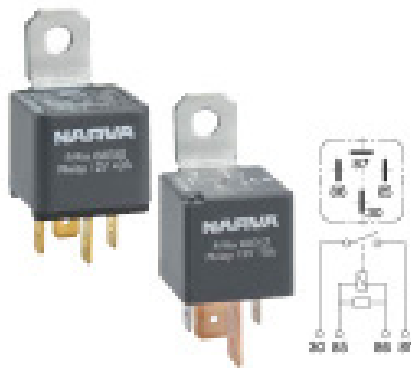

Fig. 2: 4 pin relay and variants over 50 amp have a 9.5mm pin (86) and 87 terminals

PART NO.	VOLT	AMP	PIN	CONTACT	PROTECTION
----------	------	-----	-----	---------	------------

NORMALLY OPEN CONTACTS 4 PIN

68000 68000BL	12V	40	4	0.14	-
68004 68004BL	12V	40	4	0.18	Resistor
68008 68008BL	12V	50	4	0.18	Resistor
68012 68012BL	12V	70	4	0.18	Resistor
68016 68016BL	24V	30	4	0.11	Resistor
68020 68020BL	24V	50	4	0.07	-



NORMALLY OPEN 4 PIN - REVERSE PIN

68021BL 68021BL	12V	30	4	0.15	Resistor
---------------------------	-----	----	---	------	----------



NORMALLY OPEN - HEAVY-DUTY

68022	12V	200	4	0.05	-
68023	24V	100	4	0.18	-

RELAYS



PART NO.	VOLT	AMP	PIN	CURRENT (COIL)	FUNCTION
NORMALLY OPEN CONTACTS 5 PIN					
68024 68024BL	12V	30	5	0.14	-
68028	12V	40	5	0.18	Resistor
68028BL					
68032	12V	40	5	0.15	Diode
68032BL					
68036	24V	30	5	0.09	Resistor
68036BL					
68040	24V	30	5	0.08	Diode
68040BL					



PART NO.	VOLT	AMP	PIN	CURRENT (COIL)	FUNCTION
NORMALLY OPEN - TWIN					
68042	12V	30/30	5/5	0.15/ 0.15	-

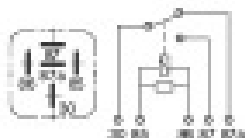

PART NO.	VOLT	AMP	PIN	CURRENT (COIL)	FUNCTION
CHANGE-OVER CONTACTS 5 PIN					
68044 68044BL	12V	40/30	5	0.16	Resistor
68048	12V	40/30	5	0.15	Diode
68048BL					
68052	24V	30/20	5	0.09	Resistor
68052BL					
68056	24V	30/20	5	0.08	Diode
68056BL					

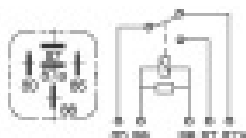

PART NO.	VOLT	AMP	PIN	CURRENT (COIL)	FUNCTION
CHANGE-OVER 5 PIN - REVERSE PIN					
68057BL	12V	30/20	5	0.15	Resistor

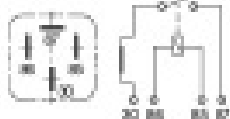

PART NO.	VOLT	AMP	PIN	CURRENT (COIL)	FUNCTION
FUSED RELAY 4 PIN					
68060 68060BL	12V	30	4	0.15	Fuse

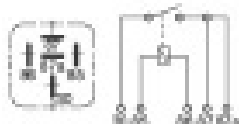

PART NO.	VOLT	AMP	PIN	CURRENT (COIL)	FUNCTION
5 PIN MINI RELAY					
72386BL	12V	30	5	0.15	Resistor

SWITCHES, FLASHERS, RELAYS & HORNS

RELAYS

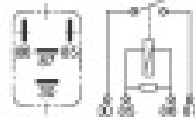

PART NO.	VOLT	AMP	PKG	CURRENT (Amp)	PROTECTION
----------	------	-----	-----	---------------	------------

MICRO RELAYS

NORMALLY OPEN CONTACTS 4 PIN

68062 68062BL Blister Pack	12V	20	4	0.15	Resistor
68066 68066BL Blister Pack	24V	10	4	0.10	Resistor

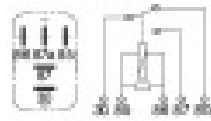

CHANGE-OVER CONTACTS 5 PIN

68070 68070BL Blister Pack	12V	30/30	5	0.15	Resistor
68074 68074BL Blister Pack	24V	10/5	5	0.10	Resistor

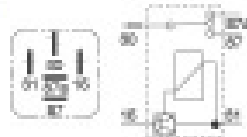
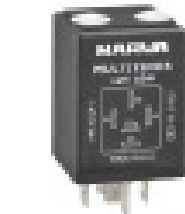

TIMER RELAYS - TIMER ADJUSTABLE

68076BL Blister Pack	12V	10	5	0.095	-
68078BL Blister Pack	24V	10	5	0.095	-

SWITCHES, FLASHERS, RELAYS & HORNS

Terminal No.	Connection
1A	+12V input signal
2B	+12V for load (common terminal)
3C	earth/ground
4D	Normally Open (NO) output
5E	Normally closed (NC) output

Multi-timer relays are used to switch an accessory 'ON' or 'OFF' after a pre-determined delay time. This can be adjusted by the two resistors on top of the housing, and can be set between 0.5 seconds and 6 hours.

- Universal applications
- Delay timing is adjustable from 0.5 seconds to 6 hours
- Can be used as either a 'DELAY ON' or 'DELAY OFF' type device
- 12V or 24V types available
- Maximum capacity of 30 Amp
- Standard relay base connection

Current draw when timer is active: Approx 0.025A
Current draw when timer is inactive: Approx 0.005A



RELAY CONNECTORS

68082 68082BL Blister Pack	Suits 4 and 5 pin relays with 6.3mm x 1.25mm flat pin connectors
68084 68084BL Blister Pack	Suits 4 and 5 pin relays with 6.3mm x 0.8mm flat pin connectors
68086 68086BL Blister Pack	Suits 4 and 5 pin relay relays with 6.3mm x 0.8mm and 6.3mm x 0.8mm flat pin connectors

Switches, Flashers, Relays & Horns - Horns & Back Up Alarms



Warning Buzzer 6 - 28V 80Db
04-766BUZZER



Warning Buzzer 12/24V 75Db
240022



Warning Buzzer Continuous Tone
72550BL



Warning Buzzer 12V 85Db
6021



Warning Buzzer 24V 85Db
6022



Reversing Buzzer 12 - 36V
6023



Disc Horn 12V 105dB
72515BL



Disc Horn 12V 118dB
72517BL



Disc Horn 24V 105dB
72525BL



Disc Horn 24V 118dB
72527BL



Horn 12V 112Db Low Tone
HORN-12V-LT



Disc Horn 12V Low Tone 115Db
HO2005



Disc Horn 12V High Tone 115Db
HO2007



Horn Disc 24V High Tone
ACX5118



Disc Horn 12V 115dB
6001



Compact Fixed Output Reversing
72604



102Db Multi Frequency White Noise
BA102



102Db Self Adjust Backup Alarm
BA102SMART



107Db Squawker Heavy
BA107



97Db Tonal Backup Alarm
BA97

WWW.MRFILTER.COM.AU

SYDNEY (02) 9769 1166

Mr Filter EST 1999
TRUCKING EARTHMOVING MINING
SUPPLIES

BRISBANE (07) 5540 7530



Reverse Alarm 12 - 80V
BBA01-MV



Reverse Alarm Self Adjusting
BBA01SA-MV



Back Up Alarm 12 - 24V 97 DB
BBS97



Back Up Alarm 12 Or 24V
ACX5153



12V Twin Air Horn Kit
72530



24V Twin Air Horn Kit
72532



Twin Air Horn 12V
HO2012



Dual Air Horn Kit 24V
HO2018



Trumpet Horn 24V 115Db
ACX5107



Horn Twin 12/24V Trumpet Truck
PK23100



Cucaracha Musical Air Horn Kit
RG9353



Musical Horn Kit
RG9355



Left Turn Speaking Alarm
SS-BCL01-KIT



Roadpower Hand Brake Alarm
BHA1000

Switches, Flashers, Relays & Horns - Master/Ignition Switches



Battery Master Switch
61075



Ignition Switch Off/On SPST
64000



2 Position HD Ignition Switch
64002



3 Position Ignition Switch
64008

WWW.MRFILTER.COM.AU



4 Position Ignition Switch
64012N



4 Position Ignition Switch
64018



4 Position Ignition Switch
64028



Ignition Switch Acc - Off - Acc/Ign
ACX3557BL



Cole Hersee 75910RBX Red
75910RBX



Battery Master Switch 125AMP
75910YBX



Battery Master / Isolation Switch
75912BX



Mini Battery Master / Isolation Switch
ACX3401BL



Red Lock-Out Lever Kit
61077R



Yellow Lock-Out Lever Kit
61077Y



Lock-out Lever Kit
61077



Lock Out Kit - Yellow
BLB4505Y



Lockout Kit Red
BMS-18R



Lockout Kit Yellow
BMS-18Y



OEX Lockout Bracket Red
ACX3432



Locking Bracket Battery
LS11003-01



Red Battery Master Switch
SW6900R



Battery Master Switch Locking
SW6901R



Yellow Start Isolation Switch
SW6900Y



Battery Isolator Lockout
BIL-RC

WWW.MRFILTER.COM.AU

SYDNEY (02) 9769 1166

Mr Filter EST 1996
TRUCKING EARTHMOVING MINING
SUPPLIES

BRISBANE (07) 5540 7530



Ignition Switch 12/24V
ACX3568



OEX Ignition Switch Acc - Off - Ign
ACX3581



Battery Master Switch
SW0171



Battery Master Switch
SW3450



Starter Master Switch With Bracket
SW3452



Battery Master Switch 750Amp
SW6902



Battery Master Switch 2,000Amp
SW6907



Battery Master Switch 1000Amp
SW6909



Battery Master Switch + Red Lock
SW6909RK



Battery Master Switch + Yellow Lock
SW6909YK



Battery Master Switch 1000Amp
SW6910



Battery Master Switch 12/24V 500Amp
SW6990



Battery Master/ Isolation Switch
0341003004



Steel Cable Lockout Handle
2050-041



Lockable Cover For E-Stop
24309



Diesel Pre-Heat Starter Switch
4005



Stop Lamp Switch Off
4565H



Battery Master/Isolation Switch
61038BL



Battery Master / Isolation Switch
ACX3409



Battery Master Switch
61039

WWW.MRFILTER.COM.AU

SYDNEY (02) 9769 1166

Mr Filter EST 1998
TRUCKING EARTHMOVING MINING
SUPPLIES

BRISBANE (07) 5540 7530



Ignition Switch 4 Positions 12V 30A
SW9428BL



Ignition Switch 12V 30Amp 3 Position
SW9460BL



Battery Master Switch Lever Type
61070



Battery Master Switch Lever Type
61074



Battery Master Heavy Duty Isolator
BMS17



Dual Pole Battery Master
61080N



Metal Key Suits 61050 Master
61051



Rotary Battery Master Switch
61036



Battery Master Switch Rotary
61084BL



Dual Battery Isolator
SBI12



Ignition Switch Key
ACX3568K



Bracket For Cole Hersee Battery Master
SW3451

Switches, Flashers, Relays & Horns - Switches



ABB 1SFA Series Red Emergency Stop
192-0852



Pedal Switch
1D410318301



Wiring Harness / Stop Switch
207-06-75430



Scania Switch Air Horn
2087170

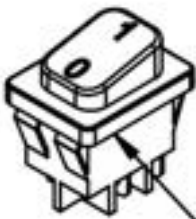

Switch To Suit 52000 Pump
52000-8



40psi Low Pressure Indicator
228750



Master Window Switch
2V2201



Pneumatic Time Delay Switch
319WE

WWW.MRFILTER.COM.AU

SYDNEY (02) 9769 1166

Mr Filter
EST 1998
TRUCKING EARTHMOVING MINING
SUPPLIES

BRISBANE (07) 5540 7530



Stop Light Switch
SW8608BL



Push/Pull Switch On/Off SPST 12V
4412H



Stop Lamp Switch On Mom Off
4562



Push/Pull Headlamp Switch
60013BL



Push/Pull Switch (Contacts Rated 15A 12V)
60016BL



Push/Pull Switch (Contacts Rated 75A 12V)
60018BL



Push/Pull Switch On/Off SPST Illuminated Red
60021BL



Push/Pull Switch Off/On SPST Illuminated Red
60022BL



Push/Pull Switch Off/On SPST
60023BL



Push/Pull Switch Off/On SPST
60024BL



Push/Push Dipper Switch On/On
60027BL



Push/Push Dipper Switch On/On
60028BL



Push Button Switch Momentary On
60030BL



Push Button Switch Momentary On
60031BL



Heavy Duty Push Button
60033BL



Momentary (On) Push
60037BL



Micro Momentary (On)
60038BL



Narva Push Button Switch
60039BL



Narva Push Button Switch
60040BL



Narva Universal Door
60041BL

WWW.MRFILTER.COM.AU

SYDNEY (02) 9769 1166

Mr Filter EST 1998
TRUCKING EARTHMOVING MINING
SUPPLIES

BRISBANE (07) 5540 7530



Toggle Switch Off/On SPST
60044BL



Spring Toggle Switch Off/Momentary
60045BL



Toggle Switch On/Off/On SPDT
60046BL



Toggle Switch Off/On SPST
60050BL



Illuminated Off/On Toggle
60051BL



Pre-wired Toggle Switch
60054BL



Metal Toggle Switch Off/On SPST
60055BL



On/Off/On Metal Toggle
60056BL



Metal Changeover Toggle
60057BL



Toggle Switch Rubber
60058BL



Missile Switch Cover
60059BL



Metal Toggle Switch Off/On SPST
60060BL



Metal Toggle Switch On/Off/On
60061BL



Toggle Switch Off/On SPST
60062BL



Toggle Momentary On/Off/Momentary On
60063BL



Toggle Switch Off/On DPST
60065BL



Toggle Switch On/Off/On DPDT
60067BL



Toggle Momentary On/Off/Momentary On
60068BL



Off/On Toggle Switch (Natural/Red)
60072BL



Off/On Heavy-Duty Toggle
60078BL

WWW.MRFILTER.COM.AU

SYDNEY (02) 9769 1166

Mr Filter
EST 1998
TRUCKING EARTHMOVING MINING
SUPPLIES

BRISBANE (07) 5540 7530



Toggle Switch On/Off/On SPDT
60080BL



Toggle Switch On/Off/Momentary
60082BL



Slide Switch Off/On SPST
60084BL



Push/Push Button Switch
60085BL



Push/Push Button Switch
60094BL



Push Button Starter Switch
60097BL



Push Button Starter Switch
60098BL



Push Button Starter Switch
60099BL



Toggle Switch Off/On SPST
60255BL



Toggle Switch Off/On SPST
60256BL



Toggle Switch Off/On SPST
60258BL



Duckbill Toggle Switch Off/On SPST
60271BL



Duckbill Toggle Switch Off/On
60273BL



HD Toggle Switch Off/On SPST
60281BL



HD Toggle Switch Off/On SPST
60283BL



Toggle Switch Off/On SPST Blue
60286BL



Toggle Switch Off/On SPST Red
60288BL



Micro Toggle Switch Off/On SPST
60290BL



Waterproof Hd Toggle Switch
60295BL



Switch Toggle On / Off 12/24V
SW5023



Toggle Switch ON/OFF
SW5042BL



Toggle Switch On/Off Spst
SW5045BL



Rotary Headlamp Switch
63216BL



Switch Rocker On / Off Green
SW8310



Rocker Switch Off/On SPST
62000BL



Switch Rocker On / Off 12/24V
SW8383



Rocker Switch Off/On SPST
62001BL



Rocker Switch Off/On SPST
62003BL



Rocker Switch Off/On SPST
62005BL



Off/On Rocker Switch with Red LED
62008BL



Rocker Switch Off/On SPST
62010BL



Rocker Switch On/Off/On
62011BL



Rocker Switch Off/On SPST
62020BL



Rocker Momentary On/Off 12/24V
SW8330



Switch Rocker On/Off 12/24V
SW8338



Switch Rocker 12V 20A
BRSW-009



Pilot Light LED Amber 12V
62026BL



12v Pilot Lamp with Blue
62027BL



Pilot Light LED Green 12V
62028BL



Pilot Light LED Red 12V
62029BL

WWW.MRFILTER.COM.AU

SYDNEY (02) 9769 1166

Mr Filter EST 1998
TRUCKING EARTHMOVING MINING
SUPPLIES

BRISBANE (07) 5540 7530



Mounting Bracket Suit Battery Switch
610702



Off/On Rocker Switch with Boot
62035BL



Rocker Switch Off/On SPST
62050BL



Rocker Switch Off/On SPST
62055BL



Rocker Switch On/On SPDT
62056BL



Rocker Switch Off/On SPST
62057BL



Rocker Switch Off/On SPST
62058BL



Rocker Switch Off/On SPST
62059BL



Pilot Light LED Green 12V
62064BL



Pilot Light LED Green 24V
62068BL



24 Volt Pilot Lamp Red
62069BL



Pilot Light Incandescent Amber
62070BL



Pilot Light Incandescent Blue
62071BL



Pilot Light Incandescent Red
62073BL



12V Pilot Lamp Pre-wired Red LED
62075BL



Pilot Light LED Red 12V Pre Wired
62076BL



24V Pilot Lamp Pre-wired Red LED
62077BL



Pilot Light LED Amber 12V
62090BL



Pilot Light LED Green 12V
62091BL



Pilot Light LED Red 12V
62092BL

WWW.MRFILTER.COM.AU

SYDNEY (02) 9769 1166

Mr Filter EST 1998
TRUCKING EARTHMOVING MINING SUPPLIES

BRISBANE (07) 5540 7530



24V Chrome Pilot Lamp Amber
62095BL



24V Chrome Pilot Lamp Green
62096BL



24V Chrome Pilot Lamp Red
62097BL



Rocker Switch Off/On DPST
63010BL



Rocker Switch On/On DPDT
63012BL



Rocker Switch Off/On DPST Amber
63020BL



Off/On Rocker Switch Red LED
63021BL



Off/On Rocker Switch Green LED
63022



Off/On Rocker Switch Red LED
63026BL



Rocker Switch Off/On DPST Green
63027BL



Off/On HD Rocker Switch BL Pk 1
63040BL



On/Off/On Hd Rocker Switch
63041BL



Off/On HD Rocker Switch
63042BL



On/Off/On HD Rocker Switch
63043BL



Rocker Momentary On/Off/Momentary On
63044BL



Illuminated Off/On Heavy-Duty Rocker
63047BL



Illuminated Off/On Heavy-Duty Rocker
63048BL



Off/Momentary (On) HD Rocker Switch
63050BL



HD Rocker Switch Off/On/On DPDT
63051BL



Off/On Sealed Rocker Switch
63100BL

WWW.MRFILTER.COM.AU

SYDNEY (02) 9769 1166

Mr Filter EST 1998
TRUCKING EARTHMOVING MINING
SUPPLIES

BRISBANE (07) 5540 7530



On/On Sealed Rocker Switch
63104BL



On/Off/On Sealed Rocker
63106BL



12 Volt Illuminated Off/On Rocker
63122BL



12 Volt Illuminated Off/On Rocker
63123BL



12 Volt Illuminated Off/On Rocker
63124BL



12 Volt Illuminated Off/On Rocker
63125BL



12 Volt Illuminated Off/Momentary (On)
63127BL



12 Volt Illuminated Off/On Rocker
63132BL



12 Volt Illuminated Off/On Rocker
63140BL



12 Volt Illuminated Off/On Rocker
63144BL



12 Volt Illuminated Off/On Rocker
63145BL



Rocker Switch Off/On SPDT 12V
63146BL



12 Volt Illuminated Off/On Rocker
63147BL



12v Winch Rocker Switch
63148BL



12/24V Off/On LED Illuminated Rocker
63158BL



12/24V Off/On LED Illuminated Rocker
63159BL



Rocker Switch On/On DPDT
63166BL



Rocker Switch On/Off/On DPDT
63168BL



Rocker Switch On/On 12/24V 20A
SW1527



Switch Carling Rocker On - Off 12V
SW1547

WWW.MRFILTER.COM.AU

SYDNEY (02) 9769 1166

Mr Filter EST 1998
TRUCKING EARTHMOVING MINING
SUPPLIES

BRISBANE (07) 5540 7530



Thunder Rocker Switch
TDR11011



6-Way LED Switch Panel
63194



Switch Rocker ON/OFF
SW8385



12/24V Off/On LED Sealed Rocker
63220BL



12/24V Off/On LED Illuminated Rocker
63224BL



12/24V Roof Lights Rocker
63226BL



12/24V Backup Lights Rocker
63230BL



12/24V Aux Lights Rocker
63232BL



12/24V Beacon Rocker Switch
63234BL



Toyota Style Switch Off/On SPDT
63316BL



Toyota Style Switch Off/On SPDT
63318BL



Rocker Mom On/Off Mom On Spdt
DT11007



Rocker Light Bar Switch On/Off SPST
A5567218



Switch Push Butt Off/Mom On 12V
SW3030



Push Button Switch Off/Mom/On
90030



PTO Switch
A06-30769-096



E-Stop Contact N/C
ACX3436



Emergency Switch On - Off /Off - On
ACX3438



Emergency Switch On - Off /Off - On
ACX3438METAL



Emergency Stop Switch
61030

WWW.MRFILTER.COM.AU

SYDNEY (02) 9769 1166

Mr Filter EST 1996
TRUCKING EARTHMOVING MINING
SUPPLIES

BRISBANE (07) 5540 7530



Rocker Switch On/Off/On SPDT
ACX3715BL



Limit Switch On - Off /Off - On
ACX7652



Switch; Power Window Rhs
8982987500



Switch; Power Window Lhs
8983164150



Micro Switch
BSMJ21315BP



Switch Micro Britax Large
BSMJ21515BP



Micro Switch
BSMV3000BBP



Micro Switch Medium
BSMV3001ABP



Micro Switch
BSMV3002ABP



Micro Switch Medium
BSMV3003ABP



Micro Switch Short Arm
BSMV3004ABP



Micro Switch
BSMV3005ABP



Emergency Stop Switch Tab
ESWT



Emergency Stop Tab Plate Round
SW-0195



Emergency Stop Mount - 22mm Switch
ESA0022



Emergency Stop Mount - 30mm Switch
ESA0030



Emergency Stop Recessed Panel
RES0542



Emergency Stop Switch - 24306
SW0182



Emergency Stop Switch Latching
SW0183



Switch Kissling Emergency Stop
KES0311

WWW.MRFILTER.COM.AU



Switch Kissling Emergency Stop
KES0312



Remote Starter Switch
SP61052

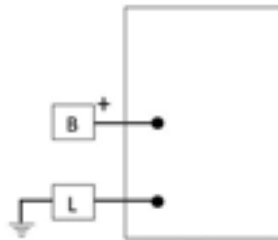

Switch Rocker Cole Hersee
58336



Jake Brake Switch
FLCA06-30769-001



Boom Pendant Harness
DI-215-2405



Pendant Hoist Switch 12/24V 2 Button
SW0154



915MHz 8 Channel Transmitter
QRRTM08



Wabco Control 44605 3340
4460563340



End Section Mounting Panel
63181BL



Middle Section Mounting Panel
63182BL



Switch Panel BL Pk 1
62040BL



Switch Panel Dual Rectangular
62046BL



Single Blanking Plate
63183BL



Limit Switch Spring Arm Lever
SW8742



Brake Light Switch
TBS038



Brake Light Switch
TBS093



Coolant Fan Temperature Switch
TFS110



In-Cabin E-Stop
TMS39



Left Hand Mirror Control
VM310LH



Right Hand Mirror Control
VM320RH

WWW.MRFILTER.COM.AU

SYDNEY (02) 9769 1166

Mr Filter EST 1996
TRUCKING EARTHMOVING MINING
SUPPLIES

BRISBANE (07) 5540 7530



Emergency Stop Switch
XB5AS542



Switch to suit BJC4000
125-C42-BJ4



Switch Scania
1421838



Switch Scania
1421851



Switch Scania
1780580



Contact Housing Switch
1443257



PR16 Pressure Switch 3/8
14529-0040-00

Terminals & Connectors - Anderson Plugs



HD Socket 2 Pole 1 Pce
57200BL



HD 175 Amp Connector
57215



HD 350 Amp Connector
57230



50A Genuine Anderson Connector,
ACX2760



Anderson Plug Terminals 50A
ACX2760T



Plastic Cover Suit 175A Anderson Plug
ACX2762HC



Anderson Plug 2 Pole 350A 1 Kit
ACX2764



120A Anderson Plug Pair
ACX2767



Anderson Connector 50Amp
ECH0050



Red Anderson Plug Red
ECH0055



Anderson Connector
ECH0175



Anderson Connector
ECH0177

WWW.MRFILTER.COM.AU



Anderson Connector Hd 350A Grey
ECH0350



Anderson Connector Hd 350Amp Red
ECH0353



Black Anderson Plug Cover
ECH0179



Anderson Plug Cover Red
ECH0180



Black Anderson Plug Cover
ECH0053



Red Anderson Plug Cover
ECH0054



Cover Red - 350A Anderson Plug
ECH0351



Anderson Plug to Ring Terminal Adapter
HU6960



Anderson Plug 50A - Acc Plug Cable
HU6966



Cover T/S 175A Anderson Plug
ECH0182



Plastic Handle To Suit Anderson Plug
ECH0181

Terminals & Connectors - Assortment Kits



180Pc Terminal Assortment
37144



Q.C Connector Assortment Kit
56250



Professional Terminal & Connector
56530



AMP Seal Connector Assortment
57500



Deutsch Dt Series Assortment Kit
DTKIT-1



Connector Housing Assortment Kit
ECH250BKIT



Connector Housing Assortment Kit
ECH250WKIT



339 Pc 1.5 Superseal Terminal Connector
ECHK339

WWW.MRFILTER.COM.AU

SYDNEY (02) 9769 1166

Mr Filter EST 1998
TRUCKING EARTHMOVING MINING
SUPPLIES

BRISBANE (07) 5540 7530



450pc Wire Terminal Kit With Crimper
PT20701



61pc Wire Terminal Kit With Crimper
PT20704



410pc Wire Terminal Kit
PT91500



175pc Wire Terminal Kit
RG28152



Double Crimped Terminal Assortment
TE7001



Professional 400pc Terminal Kit
TK340



Double Crimped Terminal Assortment
TE7000



Crimp Terminal Assortment Kit
TE7004



Crimp Terminal Assortment Kit
TKP700



Solder Splice 1.5-2.7Mm Red Pk25
TE5016



Solder Splice 1.5-2.7Mm Blue Pk25
TE5017



Jump Start Terminal Connector Kit
HM7546KIT

Terminals & Connectors - Battery Clamps



HD Alligator Clip Set
1780323S



Battery Clamp Negative
57320



Battery Clamp Positive
57322



Packet 2 Battery Clamps
BC0100



Projecta Battery Clamp
BC1000B



Pkt 2 1000A Battery Clamps
BC1000BL



Projecta Battery Clamp
BC1000R



Boost MAX 72-inch Battery Clamps
GBC005

WWW.MRFILTER.COM.AU



Battery Hold Down Clamp 7"
MA98101



Battery Hold Down Adjustable
MA98105



Battery Clip - 2Pc 5Amp
RG5047



Battery Clip - 2Pc 10Amp
RG5048



Battery Clip - 2Pc 20Amp
RG5049



Aligator Clamp Pair 50Amp
TC25



Aligator Clamp Pair 100Amp
TC75

Terminals & Connectors - Battery Terminals



Handyman Terminal Assortment
56520



Stud Single Terminal
ACX0032



Crimp Terminal Fully Insulated Red
ACX3022



Female Blade Blue Terminal
ACX3024



Stud Terminal Insulator End Entry Black
ACX3121



Stud Terminal Insulator - Red
ACX3124



Stud Terminal Insulator End Entry Red
ACX3128



Silver Pltd Terminal T/S 50 & 75Amps
ECH0051



Stud Terminal Negative
MA100NBL1



Stud Terminal Positive
MA100PBL1



Battery Terminal Universal Saddle
MA11



Saddle Terminal Universal
MA11BL1

WWW.MRFILTER.COM.AU

SYDNEY (02) 9769 1166

Mr Filter
EST 1996
TRUCKING EARTHMOVING MINING
SUPPLIES

BRISBANE (07) 5540 7530



Heavy Duty Saddle Type Terminal
MA11HDBL1



Heavy Duty Bolt Type Terminal
MA142HDBL2



Battery Terminal Negative
MA142HDN



Battery Terminal Box Of 5
MA142HDNB5



Battery Terminal Positive
MA142HDP



Battery Terminal Box Of 5
MA142HDPB5



Wingnut Type HD Terminal Pair
MA14HDBL2



HD Wingnut Terminal Negative
MA14HDNBL1



HD Wingnut Terminal Positive
MA14HDPBL1



Wingnut Terminal Negative
MA14NBL1



Wingnut Terminal Positive
MA14PBL1



Battery Terminal Isolator
MA2323



Rear Entry Terminal Up To 35mm2
MA32BL1



HD Rear Entry Terminal Up To 65mm2
MA32HDBL1



Saddle Small Terminal Negative
MA36STNBL1



Saddle Small Terminal Positive
MA36STPBL1



Side Entry Terminal Negative
MA39NBL1



Side Entry Terminal Positive
MA39PBL1



Packet 10 Battery Terminal 10Mm
TL218BTP



Terminal Assortment Pack Of 50
MABTP50

WWW.MRFILTER.COM.AU















TERMINALS & CONNECTORS

TERMINALS, CONNECTORS & CABLES

ITEM PART NO.	QTY PER PACK	CODE PART NO.	QTY PER PACK	DESCRIPTION	WIRE SIZE (mm)	INSUL. COV. DIA. (mm)	INSUL. THICK. (mm)
HIGH HEAT RESISTANCE DOUBLE CRIMPED							
		560118BL	8	560111	2.5 - 3mm	4.2 x 0.8	1/4"
		560128BL	8		4mm		
		560138BL	8		5 - 6mm		
DOUBLE CRIMPED							
		560148BL	8	560114	2.5 - 3mm	4.2 x 0.8	1/4"
		560158BL	8		4mm		
DOUBLE CRIMPED							
		560208BL	14	560120	2.5 - 3mm	4.2 x 0.8	1/4"
		560228BL	14		4mm		
		560248BL	11		5 - 6mm		
		560288BL	17	560128	-	4.2 x 0.8	1/4"
DOUBLE CRIMPED							
		560308BL	10	560130	2.5 - 3mm	4.2 x 0.8	1/4"
		560328BL	10		4mm		
DOUBLE CRIMPED							
		560338BL	18	560133	2.5 - 3mm	2.8 x 0.8	1/8"
		560348BL	18		4mm	4.2 x 0.8	1/4"
		560368BL	14		4mm	4.2 x 0.8	1/4"
		560378BL	12		4mm	4.0 x 0.8	5/16"
		560388BL	12		4mm	4.2 x 0.8	1/4"
		560408BL	10		4mm	4.5 x 1.2	3/8"

*Angular measurements approx. only

TERMINALS & CONNECTORS

BLADE PART NO.	QTY PER PACK	WIRE PART NO.	QTY PER PACK	DESCRIPTION	WIRE SIZE (mm ²)	WIRE DIA. (mm)	Length (mm)
HIGH HEAT RESISTANCE DOUBLE CRIMPED							
		56041BL	56141	Female blade terminal, transparent polycarbonate, fully insulated	2.5 - 3mm		
DOUBLE CRIMPED							
		56042BL	56142	Female blade terminal, flared vinyl fully insulated	2.5 - 3mm		
HIGH HEAT RESISTANCE DOUBLE CRIMPED							
		56043BL	56143	Female blade terminal, transparent polycarbonate, fully insulated	4mm	6.3 x 0.8	14"
DOUBLE CRIMPED							
		56044BL	56144	Female blade terminal, flared vinyl fully insulated	4mm		
HIGH HEAT RESISTANCE DOUBLE CRIMPED							
		56045BL	56145	Female blade terminal, transparent polycarbonate, fully insulated	5 - 6mm		
DOUBLE CRIMPED							
		56046BL	56146	Male bullet terminal, flared vinyl insulated	2.5 - 3mm		502"
HIGH HEAT RESISTANCE DOUBLE CRIMPED							
		56047BL	56147	Male bullet terminal, transparent polycarbonate	2.5 - 3mm	4.0	502"
DOUBLE CRIMPED							
		56048BL	56148	Male bullet terminal, flared vinyl insulated	4mm	5.0	316"
HIGH HEAT RESISTANCE DOUBLE CRIMPED							
		56049BL	56149	Male bullet terminal, transparent polycarbonate	4mm	4.0	502"
DOUBLE CRIMPED							
		56050BL	56150	Female bullet terminal, flared vinyl insulated	2.5 - 3mm	4.0	502"
HIGH HEAT RESISTANCE DOUBLE CRIMPED							
		56051BL	56151	Female bullet terminal, transparent polycarbonate	2.5 - 3mm		
DOUBLE CRIMPED							
		56052BL	56152	Female bullet terminal, flared vinyl insulated	4mm	5.0	316"
HIGH HEAT RESISTANCE DOUBLE CRIMPED							
		56053BL	56153	Female bullet terminal, transparent polycarbonate	4mm	4.0	502"
DOUBLE CRIMPED							
		56055BL	56155	Male bullet terminal, flared vinyl insulated	5 - 6mm	5.0	316"
DOUBLE CRIMPED							
		56057BL	56157	Female bullet terminal, flared vinyl insulated			

TERMINALS, CONNECTORS & CABLES

*Imperial measurements approx. only

MR FILTER 2019/20 CATALOGUE | 219

WWW.MRFILTER.COM.AU





Mr Filter EST 1998
TRUCKING EARTH-MOVING MINING SUPPLIES

SYDNEY (02) 9769 1166

BRISBANE (07) 5540 7530

TERMINALS & CONNECTORS

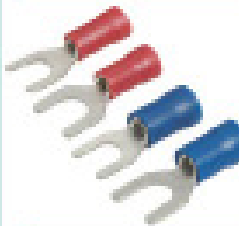
TERMINALS, CONNECTORS & CABLES

BLADE PART NO.	QTY PER PACK	ORDER PART NO.	QTY PER PACK	DESCRIPTION	WIRE SIZE (mm)	LENGTH (mm)	LENGTH (IN)
 56064BL	15	56154		Cable jointer flared vinyl, fully insulated (butt splice)	2.5 - 3mm	-	-
56066BL	14	56156	100		4mm	-	-
56058BL	8	56158			5 - 6mm	-	-
 56060BL	5	56160	50	Wire tap connectors universal application to quickly connect cable	3 - 4mm	-	-
 56062BL	21	56162	100	Spade terminal flared vinyl, insulated (eye terminal)	2.5 - 3mm	4.3	5/32"
56064BL	21	56164				5.0	3/16"
56066BL	20	56166		Spade terminal flared vinyl, insulated	4mm	4.3	5/32"
56068BL	21	56168				5.0	3/16"
 56069BL	25	56169	100	Ring terminal flared vinyl, insulated (eye terminal)	2.5 - 3mm	3.0	1/8"
56070BL	25	56170				4.3	5/32"
56072BL	25	56172				5.0	3/16"
56074BL	16	56174				6.3	1/4"
56075BL	16	56175				8.4	5/16"
56076BL	25	56176		Ring terminal flared vinyl, insulated (eye terminal)	4mm	4.3	5/32"
56078BL	25	56178				5.0	3/16"
56080BL	20	56180				6.3	1/4"
56082BL	14	56182				8.4	5/16"
56083BL	12	56183				9.5	3/8"
56084BL	14	56184	100	Ring terminal flared vinyl, insulated (eye terminal)	5 - 6mm	4.3	5/32"
56086BL	14	56186				5.0	3/16"
56088BL	12	56188				6.3	1/4"
56090BL	10	56190				8.4	5/16"
56092BL	10	56192				9.5	3/8"
56093BL	12	56193				13.0	1/2"

*length measurements approx. only

TRADE TERMINALS

TERMINALS, CONNECTORS & CABLES

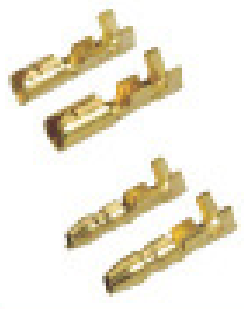

PART NO.	QTY PER BOX	DESCRIPTION	WIRE SIZE (mm)	WIRE GA. (AWG)	TERMINAL GA. (mm)
NON-INSULATED BULLET TERMINALS					
56201	100	Bullet female terminal non-insulated brass	2.5 - 3mm	4.0	5/32"
56203			4mm	5.0	3/16"
56206	100	Bullet male terminal non-insulated brass	2.5 - 3mm	4.0	5/32"
56207			4mm	5.0	3/16"



PART NO.	QTY PER BOX	DESCRIPTION	WIRE SIZE (mm)	WIRE GA. (AWG)	TERMINAL GA. (mm)
PIN TERMINALS					
56212	25	Pin terminal flared vinyl insulated	2.5 - 3mm	2.0	3/32"
56214			4mm	2.0	1/16"
56216			6 - 6mm	2.5	3/32"



PART NO.	QTY PER BOX	DESCRIPTION	WIRE SIZE (mm)	WIRE GA. (AWG)	TERMINAL GA. (mm)
NON-INSULATED BLADE TERMINALS					
56218	100	Blade male terminal non-insulated brass with locking tab	1 - 3mm	2.8 x 0.8	1/16"
56220			1 - 4mm	6.3 x 0.8	1/8"
56222	100	Blade female terminal non-insulated brass with locking tab	1 - 3mm	2.8 x 0.8	1/16"
56223			1 - 3mm	4.8 x 0.8	3/32"
56224			1 - 4mm	6.3 x 0.8	1/8"
56225			1 - 6mm	9.5 x 1.2	3/16"
56226	100	Blade female terminal non-insulated brass with locking tongue for single Q.C. housings	1 - 4mm	6.3 x 0.8	1/8"



PART NO.	QTY PER BOX	DESCRIPTION	WIRE SIZE (mm)	WIRE GA. (AWG)	TERMINAL GA. (mm)
NON-INSULATED FLAG TERMINALS					
56228	100	Flag terminal non-insulated brass	1 - 4mm	6.3 x 0.8	1/8"



PART NO.	QTY PER BOX	DESCRIPTION	WIRE SIZE (mm)	WIRE GA. (AWG)	TERMINAL GA. (mm)
WEATHERPROOF CONNECTOR TERMINALS					
56230	50	Female socket terminal to suit weatherproof connector	1 - 2mm	3.0	1/8"
56231	50	Male pin terminal to suit weatherproof connector	1 - 2mm	3.0	1/8"

*typical measurements apply only

TRADE TERMINALS



PART NO.	QTY PER PACK	DESCRIPTION	WIRE SIZE (mm)	Ø (mm)	Ø (in)
NON-INSULATED RING TERMINALS					
56232	100	Ring terminal non-insulated base (open end)	1 - 3mm	4.2	5/32"
56234			1 - 4mm	5.0	5/16"
56236			1 - 3mm	6.2	1/4"
56240			1 - 4mm	8.4	5/8"



PART NO.	QTY PER PACK	DESCRIPTION	WIRE SIZE (mm)	Ø (mm)	Ø (in)
BLADE TERMINAL INSULATOR					
56244	100	Suits 6.2mm female 56234	-	-	-



PART NO.	QTY PER PACK	DESCRIPTION	WIRE SIZE (mm)	Ø (mm)	Ø (in)
BULLET TERMINAL INSULATOR					
56247	100	Suits 4mm female 56201	-	-	-
56248		Suits 5mm female 56203	-	-	-
56249		Suits male 56205, 56207	-	-	-



PART NO.	QTY PER PACK	DESCRIPTION	WIRE SIZE (mm)	Ø (mm)	Ø (in)
AMP® SUPER SEAL CONNECTOR TERMINALS					
57537	50	Male pin terminal to suit Amp® super seal connectors	2 - 3mm (0.5 - 1.5mm ²)	1.6 x 0.8	-
57539	50	Female socket terminal to suit Amp® super seal connectors	2 - 3mm (0.5 - 1.5mm ²)	2.6 x 2.5	-



PART NO.	QTY PER PACK	DESCRIPTION	WIRE SIZE (mm)	Ø (mm)	Ø (in)
SOLID DEUTSCH® CONNECTOR TERMINALS					
57436	50	Size 12 Male pin terminal to suit Deutsch® connectors	6mm	0460-204-121-41	25
57437	50	Size 12 Female socket terminal to suit Deutsch® connectors		0462-209-121-41	
57440	50	Size 14 Male pin terminal to suit Deutsch® connectors	4mm	0460-215-161-41	13
57441	50	Size 14 Female socket terminal to suit Deutsch® connectors		0462-209-161-41	
57438	50	Size 16 Male pin terminal to suit Deutsch® connectors	3mm	0460-202-161-41	13
57439	50	Size 16 Female socket terminal to suit Deutsch® connectors		0462-201-161-41	
57442	50	Size 20 Male pin terminal to suit Deutsch® connectors	2 - 3mm	0460-202-201-41	7.5
57443	50	Size 20 Female socket terminal to suit Deutsch® connectors		0462-201-201-41	



PART NO.	QTY PER PACK	DESCRIPTION	WIRE SIZE (mm)	Ø (mm)	Ø (in)
DEUTSCH® CONNECTOR TERMINALS					
57444	50	Size 16 Male pin terminal to suit Deutsch® connectors	1 - 3mm	1060-35-0122	13
57445	50	Size 16 Female socket terminal to suit Deutsch® connectors	1 - 3mm	1062-35-0122	13

*typical measurements approx. only

MRFLTR 2016/20 CATALOGUE | 223

TERMINALS, CONNECTORS & CABLES

WWW.MRFILTER.COM.AU

SYDNEY (02) 9769 1166

Mr Filter
EST 1996
TRUCKING EARTHMOVING MINING SUPPLIES

BRISBANE (07) 5540 7530

TERMINAL CONNECTOR STRIPS & BUS BARS

TERMINALS, CONNECTORS & CABLES



PART No.	QTY PER PACK	DESCRIPTION	AMP RAT PG	WIRE SIZE (mm ²)
56280 56280BL	10 Blister (1)	Strip of 12 terminal blocks, manufactured of polyamide (nylon), with a maximum operating temperature of 105°C	20A	1.5mm ²
56281 56281BL	10 Blister (1)		30A	2.5mm ²
56282 56282BL	10 Blister (1)		35A	5.5mm ²
56283 56283BL	10 Blister (1)		50A	8mm ²



56284BL Blister Pack
Multi-purpose Bus Bar (6P)
 Consisting of tin-plated brass bus bar with insulated mounting bases, 6 x M4 threaded studs and flexible rubber push on cover
 Rating: 300V AC/48V DC max
 M4 Threaded Studs (100A max)



56285BL Blister Pack
Multi-purpose Bus Bar (12P)
 Consisting of tin-plated brass bus bar with insulated mounting bases, 12 x M4 threaded studs and flexible rubber push on cover
 Rating: 300V AC/48V DC max
 M4 Threaded Studs (100A*2 max)

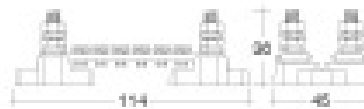

ADHESIVE LINED HEATSHRINK TERMINALS

The internal adhesive of the heatshrink terminals bonds securely to both the terminal and cable. The combination of crimping, heatshrink and adhesive creates a level of strain relief not achievable with standard terminal types.

The shrink/adhesive combination also produces a seal that prevents water and dust getting into the back of the terminal.

1 Select the correct size terminal for your application and crimp as per standard terminals.

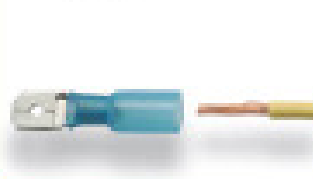

2 Apply heat. As can be seen, the terminal insulation not only shrinks firmly around the cable but also releases an adhesive to increase the strain relief and create a watertight seal.



The 56392BL Flameless Heat Gun is ideal for use with heatshrink terminals (refer page 227).

Part No.	Wire Size (mm)	Description	Wire Size (mm)	Length (mm)	Length (inches)
56320 56320BL	50 Blister (20)	Blade male terminal, transparent heat shrinkable high density polyolefin. Adhesive lined	2.5 - 3mm	6.3 x 0.8	3/4"
			4mm		
			5 - 6mm		
56322 56322BL	50 Blister (20)	Blade female terminal, transparent heat shrinkable high density polyolefin. Adhesive lined	2.5 - 3mm	6.3 x 0.8	3/4"
			4mm		
			5 - 6mm		
56324 56324BL	50 Blister (15)	Blade female terminal, transparent heat shrinkable high density polyolefin. Adhesive lined	2.5 - 3mm	6.3 x 0.8	3/4"
			4mm		
			5 - 6mm		
56328 56328BL	50 Blister (20)	Blade female terminal, transparent heat shrinkable high density polyolefin. Adhesive lined	2.5 - 3mm	6.3 x 0.8	3/4"
			4mm		
			5 - 6mm		
56330 56330BL	50 Blister (20)	Blade female terminal, transparent heat shrinkable high density polyolefin. Adhesive lined	2.5 - 3mm	6.3 x 0.8	3/4"
			4mm		
			5 - 6mm		
56332 56332BL	50 Blister (15)	Blade female terminal, transparent heat shrinkable high density polyolefin. Adhesive lined	2.5 - 3mm	6.3 x 0.8	3/4"
			4mm		
			5 - 6mm		
56350 56350BL	50 Blister (12)	Cable joint, transparent heat shrinkable high density polyolefin. Adhesive lined	2.5 - 3mm	-	-
			4mm	-	-
			5 - 6mm	-	-
56358 56358BL	50 Blister (20)	Ring terminal, transparent heat shrinkable high density polyolefin. Adhesive lined	2.5 - 3mm	4.3	3/4"
			5.0	5.0	3/4"
			6.3	6.3	3/4"

*Repeat measurements apply only

ADHESIVE LINED HEATSHRINK TERMINALS

TERMINALS, CONNECTORS & CABLES



*Repeat measurements apply only

PART No.	QTY PER BOX	DESCRIPTION	WIRE SIZE (mm)	TIE ON DIA. (mm)	
56364 56364BL	50 Blister (20)	Ring terminal, transparent heat shrinkable high density polyolefin. Adhesive lined.	4mm	5.0	3/16"
56366 56366BL	50 Blister (20)			6.3	1/4"
56368 56368BL	50 Blister (20)			8.4	5/16"
56370 56370BL	50 Blister (12)		5 - 6mm	6.3	1/4"
56372 56372BL	50 Blister (15)			8.4	5/16"
56374 56374BL	50 Blister (12)			9.5	3/8"

SOLDER SPLICE TERMINATORS

Solder Splice Terminators combine all the advantages of heatshrink, low melt solder and waterproofing protection glands - creating a fast, waterproof, electrically reliable and fully insulated connection without the use of a soldering iron, crimping tool or solder. The 56382BL Flameless Heat Gun is ideal for use with Solder Splice Terminators.

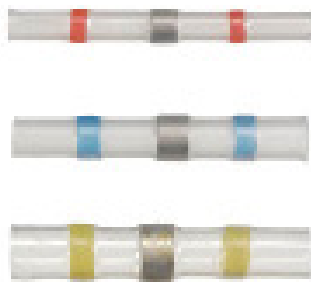
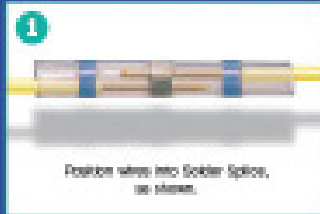

PART No.	QTY PER BOX	DESCRIPTION	WIRE SIZE (mm)
56380 56380BL	25 Blister (5)	Solder Splice terminator incorporating heatshrink and low melt solder with protection glands	1.5 - 2.5mm
56382 56382BL	25 Blister (5)		2.5 - 4.5mm
56384 56384BL	25 Blister (5)		4.5 - 6mm

228 | MARCH 2015/30 DATLOGUE

WWW.MRFILTER.COM.AU

Mr Filter EST 1998
TRUCKING EARTH-MOVING MINING SUPPLIES

SYDNEY (02) 9769 1166

BRISBANE (07) 5540 7530

DTM DEUTSCH® CONNECTOR KITS

ALL NEW

TERMINALS, CONNECTORS & CABLES



LISTED PART NO.	QTY PER PACK	DESCRIPTION
57302BL	Blister Pair (Male/Female)	2 Way DTM Connector Kit with Wedges and size 20 Terminals. Amp Rating: 7.5A
57303BL	Blister Pair (Male/Female)	3 Way DTM Connector Kit with Wedges and size 20 Terminals. Amp Rating: 7.5A
57304BL	Blister Pair (Male/Female)	4 Way DTM Connector Kit with Wedges and size 20 Terminals. Amp Rating: 7.5A
57306BL	Blister Pair (Male/Female)	6 Way DTM Connector Kit with Wedges and size 20 Terminals. Amp Rating: 7.5A
57308BL	Blister Pair (Male/Female)	8 Way DTM Connector Kit with Wedges and size 20 Terminals. Amp Rating: 7.5A
57312BL	Blister Pair (Male/Female)	12 Way DTM Connector Kit with Wedges and size 20 Terminals. Amp Rating: 7.5A



57313
DTM Deutsch® Connector Housing Assortment
 Contains a comprehensive assortment of DTM Deutsch® connectors including male and female terminals. Packed in a quality plastic case with an identification chart for easy re-ordering.

Contents (each)

57302BL x 10	57306BL x 3
57303BL x 3	57308BL x 2
57304BL x 6	57312BL x 2

DTP DEUTSCH® CONNECTORS



LISTED PART NO.	QTY PER PACK	DESCRIPTION
57314BL	Blister Pair (Male/Female)	2 Way DTP Connector Kit with Wedges and size 12 Terminals. Amp Rating: 35A
57316BL	Blister Pair (Male/Female)	4 Way DTP Connector Kit with Wedges and size 12 Terminals. Amp Rating: 35A

DEUTSCH® CONNECTORS



MALE HOUSING PART No.	DT 100 PACE	FEMALE HOUSING PART No.	DT 100 PACE	DESCRIPTION
57402	10	57412	10	2 Way DT Connector with Wedges and size 16 Terminals. Amp Rating: 15A
57422BL	Mister Pair (Male/Female)			
5742210	10 Pack Pair (Male/Female)		NEW	
57403	10	57413	10	3 Way DT Connector with Wedges and size 16 Terminals. Amp Rating: 15A
57423BL	Mister Pair (Male/Female)			
5742310	10 Pack Pair (Male/Female)		NEW	
57404	10	57414	10	4 Way DT Connector with Wedges and size 16 Terminals. Amp Rating: 15A
57424BL	Mister Pair (Male/Female)			
5742410	10 Pack Pair (Male/Female)		NEW	
57406	10	57416	10	6 Way DT Connector with Wedges and size 16 Terminals. Amp Rating: 15A
57426BL	Mister Pair (Male/Female)			
5742610	10 Pack Pair (Male/Female)		NEW	
57408	10	57418	10	8 Way DT Connector with Wedges and size 16 Terminals. Amp Rating: 15A
57428BL	Mister Pair (Male/Female)			
5742810	10 Pack Pair (Male/Female)		NEW	
57410	10	57420	10	12 Way DT Connector with Wedges and size 16 Terminals. Amp Rating: 15A
57430BL	Mister Pair (Male/Female)			
5743010	10 Pack Pair (Male/Female)		NEW	

TERMINALS, CONNECTORS & CABLES

SPARE TERMINALS AVAILABLE ON PAGE 223

PART NO. / DESCRIPTION

57400

Deutsch® Connector Assortment

Contains a comprehensive assortment of Deutsch® DT Series high and connectors including male and female terminals. Packed in a quality plastic case with an identification chart for easy re-ordering.

Comprises: (units)

57402 x 10	57410 x 2	57418 x 2
57403 x 8	57412 x 10	57420 x 2
57404 x 6	57413 x 3	57441 x 111
57406 x 2	57414 x 6	57441 x 111
57408 x 2	57416 x 3	



MAPVA 2019/20 CATALOGUE | 237

WWW.MRFILTER.COM.AU









Mr Filter EST 1998
TRUCKING EARTHMOVING MINING
SUPPLIES

SYDNEY (02) 9769 1166

BRISBANE (07) 5540 7530

WATERPROOF CONNECTORS

TERMINALS, CONNECTORS & CABLES

MALE HOUSING PART No.	QTY PER PACK	FEMALE HOUSING PART No.	QTY PER PACK	DESCRIPTION
 Part No. 56451		 Part No. 56461		1 way Waterproof Connector with Terminals and Seals Amperage rating: 20A
56471BL	Blister per pair (male/female)			
 Part No. 56452		 Part No. 56462		2 way Waterproof Connector with Terminals and Seals Amperage rating: 20A
56472BL	Blister per pair (male/female)			
 Part No. 56453		 Part No. 56463		3 way Waterproof Connector with Terminals and Seals Amperage rating: 20A
56473BL	Blister per pair (male/female)			
 Part No. 56454		 Part No. 56464		4 way Waterproof Connector with Terminals and Seals Amperage rating: 20A
56474BL	Blister per pair (male/female)			



Spare Parts to suit Waterproof Connectors

- 56230** Female Socket Terminal (50)
- 56231** Male Pin Terminal (50)

NB: Use Part No. 56509 or 56510 Crimping Tool for quality finish

PART No. / DESCRIPTION

56450

Waterproof Connector Assortment



Contains the full range of Harsco waterproof connectors including male and female terminals. Packed in a quality plastic case with an identification chart for easy re-ordering.

Comprises: (units)

56451 x 5	56461 x 5	56230 x 77
56452 x 15	56462 x 15	56231 x 77
56453 x 5	56463 x 5	
56454 x 5	56464 x 5	



AMP® SUPER SEAL CONNECTORS

TERMINAL HOLDING PART NO.	QTY. PER PACK	MALE HOLDING PART NO.	QTY. PER PACK	DESCRIPTION
 P/Nb. 57501		 P/Nb. 57511		1 way Waterproof Connector with Terminals and Seals Average rating: 14A
	10	57511	30	
		57521BL		Blower per pair (male/female)
 P/Nb. 57502		 P/Nb. 57512		2 way Waterproof Connector with Terminals and Seals Average rating: 14A
	10	57512	30	
		57522BL		Blower per pair (male/female)
 P/Nb. 57503		 P/Nb. 57513		3 way Waterproof Connector with Terminals and Seals Average rating: 14A
	10	57513	30	
		57523BL		Blower per pair (male/female)
 P/Nb. 57504		 P/Nb. 57514		4 way Waterproof Connector with Terminals and Seals Average rating: 14A
	10	57514	30	
		57524BL		Blower per pair (male/female)
 P/Nb. 57505		 P/Nb. 57515		5 way Waterproof Connector with Terminals and Seals Average rating: 14A
	10	57515	30	
		57525BL		Blower per pair (male/female)
 P/Nb. 57506		 P/Nb. 57516		6 way Waterproof Connector with Terminals and Seals Average rating: 14A
	10	57516	30	
		57526BL		Blower per pair (male/female)
Spare Parts to suit AMP® Connectors				
 P/Nb. 57557	57557 Male Pin Terminal (50)			
 P/Nb. 57559	57559 Female Socket Terminal (50)			
NB: Use P/Nb. 56517 Crimping Tool for quality finish				

TERMINALS, CONNECTORS & CABLES

P/Nb. / DESCRIPTION

57500

AMP® Super Seal Connector Assortment

Contains the full range of AMP® Super Seal connectors including male and female terminals. Packed in a quality plastic case with an identification chart for easy re-ordering

Comprises: (units)

57501 x 5	57506 x 2	57515 x 2
57502 x 10	57511 x 5	57516 x 2
57503 x 10	57512 x 10	57517 x 97
57504 x 5	57513 x 10	57539 x 97
57505 x 2	57514 x 5	



MRFLTR 2019/20 CATALOGUE | 239

WWW.MRFLTR.COM.AU

Mr Filter EST 1994
TRUCKING EARTHMOVING MINING
SUPPLIES

SYDNEY (02) 9769 1166

BRISBANE (07) 5540 7530

Trailer Connectors & Suzi Coils - Suzi Coils



Suzi Coil 7 Core (6 x 2mm / 1 x 3mm) 4.6M
82524



Suzi Coil 7 Core Metal Plugs 4.6m
82528



Suzi Coil 7 Core Metal Plugs 4.6m Long Tail
82529



Suzi Coil 7 Core (6 x 2mm / 1 x 3mm) 4.6M
82536



7 Core Suzi Coil, 4.6 metres No Plugs
82540



Suzi Coil 7 Core Metal Plugs 4.6m
82556



Suzi Coil Short Tail
A85647X1-2



Suzi Coil Long Tail
CA2561

Trailer Connectors & Suzi Coils - Trailer Plugs



7 Pin Flat with 1m cable + Plug
5C41



7 Pin Small Round Plastic Trailer Socket
82022BL



6 Pin Small Round Plastic Trailer Socket
82023BL



7 Pin Small Round Metal Trailer Socket
82032BL



6 Pin Small Round Metal Trailer Socket
82033BL



7 Pin Flat 'Quickfit' Trailer Socket
82042BL



Trailer Socket 7 Pin Flat - Plastic
82045BL



Trailer Socket 7 Pin Round Large - Metal
82062-25



7 Pin Large Round Metal Trailer Socket
82062BL



5 Pin Large Round Metal Trailer Socket
82063BL



Trailer Socket 12 Pin Flat, Plastic
82072BL



7 Pin HD Round Metal Trailer Socket
82094

WWW.MRFILTER.COM.AU



7 Pin Small Round Plastic Trailer Plug
82121BL



6 Pin Small Round Plastic Plug
82122BL



Trailer Plug 7 Pin Round Small - Metal
82131-20



7 Pin Small Round Metal Trailer Plug
82131BL



6 Pin Small Round Metal Trailer Plug
82132BL



7 Pin Flat 'Quickfit' Trailer Plug
82141BL



7 Pin Large Round Metal Trailer Plug
82161-25



7 Pin Large Round Metal Trailer Plug
82161BL



12 Pin Flat Trailer Plug
82171BL



7 Pin Large Round Plastic
82181BL



5 Pin Large Round Plastic
82182BL



7 Pin Quickfit Trailer Plug
82185BL



7 Pin HD Round Metal Trailer Plug
82193



7 Pin HD Round Metal Trailer Plug
82194



Trailer Adaptor 7 Pin Round Small
82205BL



Trailer Adaptor 6 Pin Round Small
82210BL



Trailer Adaptor 7 Pin Round Small
82215BL



Trailer Adaptor 6 Pin Round Small
82220BL



Adaptor 7 Pin Flat To 7 Pin Round Small
82225BL



Adaptor 7 Pin Flat To 6 Pin Round Small
82230BL

WWW.MRFILTER.COM.AU



Trailer Adaptor -7 Large Round
82235BL



Trailer Adaptor - 5 Large Round
82240BL



Adaptor 7 Pin Flat To 7 Pin Round Large
82245BL



Adaptor 7 Pin Flat To 5 Pin Round Large
82250BL



Adaptor 7 Pin Round To 5 Pin Round Large
82255BL



Adaptor 5 Pin Round To 7 Pin Round Large
82260BL



Adaptor 7 Pin Round To 7 Pin Round Small
82265BL



Adaptor 7 Pin Round To 6 Pin Round Small
82270BL



Trailer Adaptor 7 Pin Round Small
82275BL



Trailer Adaptor 6 Pin Round Small
82280BL



Trailer Socket 13 Pin Round - 7 Pin
82285BL



Flat Bracket for Small Round Plastic
82305BL



Angled bracket for Small Round Plastic
82310BL



Flat bracket for Small Round Metal
82315BL



Angled bracket for Small Round Metal
82320BL



Angled bracket for Large Round Plastic
82325BL



Round Plug Holder
82330BL



Mounting Plate For 7 Pin Flat Trailer Socket
ACX6921



7 Pin Flat Trailer Plug Plastic
TP2004



7 Pin Large Round Plastic Trailer Socket
82052BL

WWW.MRFILTER.COM.AU

SYDNEY (02) 9769 1166

Mr Filter EST 1998
TRUCKING EARTHMOVING MINING
SUPPLIES

BRISBANE (07) 5540 7530

Truck and Trailer Reflectors & Lights - LED Truck & Trailer Lighting



Led Stop/Tail/Indicator Lamp Reflector
100ARM



Led Stop/Tail/Indicator Light LED 12/24V
100BARRM



Led Stop/Tail/Indicator Lamp 12V
101BAR2



Led Stop/Tail/Indicator Lamp 12/24V
135ARM-2



Led Tail Light Stop/Tail/Indicator Lamp
135ARMG



Front Indicator + Position Light LED 24V
135CAT124



Led Stop/Tail/Indicator Lamp 12V
149BARLP2



Led Stop/Tail/Indicator Lamp 12V
150BAR



Led Stop/Tail/Indicator Lamp 12V
151BAR2



Led Stop/Tail/Ind/Reverse Lamp 2Pk
200BIRSTME2



Led Stop/Tail/Indicator/Reverse Lamp 1Pk
200BSTIRMB



Led Combination Lamp
385ARWM-2



Led Medium Jumbo Stop/Tail/Ind/Reverse
460ARWM



Medium Jumbo Led Stop/Tail/Ind Lamp
460ARRM

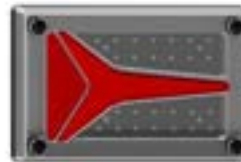

Led Stop/Tail/Indicator Lamp
595STIM-2



Stop/Tail & Indicator Lamp
201BSTIM



Sequential Indicator Lamp 12V
235ASEQ-2



Led Stop/Tail/Indicator Lamp 12V
235BBSTI112-2



Led Duraled Stop/Tail/Indicator Lamp
2378-CS



Led Stop/Tail/Indicator/Reverse Lamp
275ARWM

WWW.MRFILTER.COM.AU

SYDNEY (02) 9769 1166

Mr Filter EST 1994
TRUCKING EARTHMOVING MINING
SUPPLIES

BRISBANE (07) 5540 7530



Led Stop/Tail/Indicator/Reverse Lamp
275GARWM



Led Stop/Tail/Indicator Lamp
275MAR



Mini Jumbo Led Stop/Tail/Indicator
280ARM



Mini Jumbo Led Stop/Tail/Indicator
280ARRM



Mini Jumbo Led Stop/Tail/Ind/Reverse
280ARWM



Mini Jumbo Led Stop/Tail/Indicator/Reverse
280TARWM



Led Stop/Tail/Indicator Lamp 12-24V
282ARRM



Led Stop/Tail/Indicator/Reverse Lamp
282ARWM



Led Stop/Tail/Indicator Lamp 12/24V
283ARRM



Led Stop/Tail/Indicator/Reverse Lamp
283ARWM



Led Combination Lamp 10-30V
284ARWM-2



Lamp Stop Tail Indicator 12/24V
80BARRM



Lamp Stop Tail Indicator Reverse Led
80BARWM



Led Stop/Tail/Indicator Lamp
80BSTIM



Led Stop/Tail/Indicator/Reverse Lamp
82BARW



Led Stop/Tail/Ind/Reverse Lamp
82CARW



12V LED Slimline Trailer Lamp
93630BL2



12V LED Slimline Trailer Lamp
93640BL2



12V Model 36 Led Slimline Trailer Lamp
93642TP



LED Rear Stop/Tail/Indicator
93812BL

WWW.MRFILTER.COM.AU

SYDNEY (02) 9769 1166

Mr Filter EST 1996
TRUCKING EARTHMOVING MINING
SUPPLIES

BRISBANE (07) 5540 7530



Led Rear Tail Lamp Multivoltage
94162BL



9-33 Volt Model 42 Led Rear
94210



9-33V Model 48 Led Rear
94850



Led Stop/Tail/Indicator With Licence
99ARL2



Trailer Lamp Submersible
ASS99B



LED Trailer Lamp Kit 6x4 12V
BR207K6X4



LED Rear Combination Lamp 10-30V
BR207MV



12V Stop/Tail/ Ind/Reflector/ Licence
BR208K8X5



LED Rear Combination Lamp
BR208LRNP



10-30V Stop/Tail/Indicator/Reverse
BR601ARW



LED Rear Combination Lamp
BR80ARW



12/24V Stop/Tail/Ind/Reflector
99ARLM



Narva Stop/Tail/Indicator Light
94140BL



Narva Stop/Tail/Indicator
94202



Led Stop/ Tail/ Indicator Lamp
J3BARRM



Large Led Combination Tail Lamp
VX707ARR



Large LED Combination ARW
VX707ARW



Stop/Tail/Indicator/Reflector
MAXILAMPC3XR



Led Stop/Tail/Indicator 10-30V
VX617ARR



Led Stop/Tail/Indicator 10-30V
VX617ARR-B

WWW.MRFILTER.COM.AU



Led Combination Stop Tail
VX617ARW



Lamp Reverse Light Led 25 Leds Black
200BWM



Led Indicator Lamp 12/24V
11AM-2



Led Stop/Tail Lamp 12/24V
11RM-2



Led Reverse Lamp 12/24V
11WM-2



Led Stop/Tail/Indicator Lamp 12/24V
12ARM-2



Rear Marker Light Red LED 24V
2306H



Stop/Tail Light Led 9 to 33V
2367



Light Rear Assembly With Bulb
6670284



Round Led Interior Lamp 12V
7515C



Red Led Rear End Marker Lamp
7922RM2



Round Led Front Indicator / Position
80AW



Rear/Stop/Tail/Licence
85790BL



Rear Marker Light Red LED
93060N



Stop/Tail Light LED 24V
94412



9-33V Model 48 Led Reverse
94816H



Reverse Light LED 9 to 33V
94816V



Reverse Light Led 9 To 33V
94836H



Mini Bar Rear Lamp Combination
EA26037



Slimline - Indicator/Front Position
EA26047

WWW.MRFILTER.COM.AU

SYDNEY (02) 9769 1166

Mr Filter
EST 1998
TRUCKING EARTHMOVING MINING
SUPPLIES

BRISBANE (07) 5540 7530



Active

Led Rear End Outline Marker
EU38RMHD



Packet 2 Day Running lamp Adaptor
DRLHOTDOG2



LED Strobe Amber 9 to 33V
85222A



LED Front Indicator LED
RVFB2



Led Stop/Tail/Indicator Lamp
C1XCE



LED Rear Indicator/Tail Lamp
BR122AR



Road Vision Indicator - 8 Leds
BR122ARR



Led Round Stop/Tail/Indicator Lamp
1XC



Led Round Stop/Tail/Indicator
MAXILAMP1XC



Led Round Reversing Lamp
MAXILAMP1XCWE



Led Reversing Lamp 12/24V
100WM



Led Indicator Lamp 12/24V
110AMG



Led Stop/Tail Lamp 12/24V
110RMG



Led Reverse Lamp 10-30V
110WM



Led Reverse Lamp 12/24V
110WMG



Led Reverse Lamp 12/24V
125WM



Led Reverse Lamp 12/24V
130WMG



Rear Led Indicator Lamp 12/24V
164AM



Led Stop/Tail Lamp 12/24V
164RM



Led Reverse Lamp 12/24V
164WM

WWW.MRFILTER.COM.AU



Rear Indicator Lamp LED 9 to 33V
2144LEDH



Stop/Tail Light LED 9 to 33V
2320LEDH



10-30V Model 46 Led Rear Stop/Tail
94610



Stop/Tail Light LED 9 to 33V
2332V24



White Led Reverse Lamp
J3WM

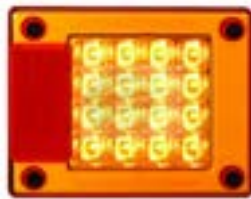

Medium Jumbo Led Indicator Lamp
460AM

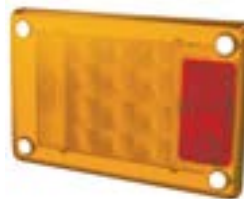

Rear Indicator Light Led 12 Or 24V
2161



Reverse Light LED 9 to 33V
94536BL



Rear Indicator Lamp LED
94528BL



Stop/Tail Light LED Red
94532BL



Amber Led Rear Indicator Lamp
82A



Amber Indicator Light 12-24V
82AMB



Red Led Rear Stop/Tail Lamp
82R



Red Rear Stop/Tail Light 12-24V
82RMB



Clear Led Rear Reverse
82W



Clear LED Autolamps Rear
82WMB



Led Interior Lamp 12V
10121



Led Interior Lamp 24V Clear
106124V



Led Stop/Tail Strip Lamp 12V 10 Square
235R12



Led Reverse Strip Lamp 12V Recessed
235W12E

WWW.MRFILTER.COM.AU

SYDNEY (02) 9769 1166

Mr Filter EST 1998
TRUCKING EARTHMOVING MINING
SUPPLIES

BRISBANE (07) 5540 7530



12V Stop Stop/Tail Strip Lamp
380R12



High Level Brake Light LED 12V
5243



Led Strip Rigid 24V Flush Mount
2156-24V



Stop/Tail Light Red 24V
2334-24V



LED Sequential Indicator Strip Lamp
BRS70AS



LED Stop Tail Strip Lamp
BRS70R



LED Reverse Strip Lamp
BRS70W



Led Interior Lamp 12V Clear
LE1061



Led Interior Lamp 24V Clear
LE106124



Mini Jumbo Led Stop/Tail Lamp
280RM



Mini Jumbo Led Reverse Lamp
280WM



Led Strip Lighting 12V 5M
LS9706



Red Lens To Suit 85720
85725



Amber lens to suit 85720
85727



Red Lens to suit 85740
85745



Amber Lens to suit 85740
85747



Lens to suit 85730
85735



Amber Lens To Suit 85950
85945



Amber Lens To Suit 86740
86747



Lens to suit 85820 Tail
85825

WWW.MRFILTER.COM.AU



Amber Lens to suit 85830
85835



Red Len Hella 9.2319.01
85855

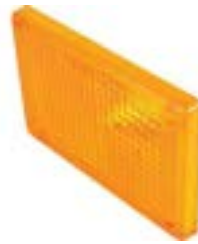

Orange Len Hella
85865



Amber lens to suit 85960 85970
85965



Red lens to suit 85960 85970
85967



Amber Lens to suit 85980, 85990
85985



Red lens to suit 85980, 85990
85987



Amber Lens To Suit 2140
9214901



Clear Lens to suit 86120
86115



Lens to suit 86460
86465



Lens to Suit 85880
85885



Red Lens To Suit 85890
85895



Amber Lens to suit 85900
85905



Lens To Suit 2419
9241901



Lens to suit 86470
86475



Hella Amber Lens To Suit 1001
9100101



Lens to suit 85750
85755



Lens To Suit 2029
2980001



Lens to suit 85760 85770
85765



Lens to suit 86010
86015

WWW.MRFILTER.COM.AU

SYDNEY (02) 9769 1166

Mr Filter EST 1998
TRUCKING EARTHMOVING MINING
SUPPLIES

BRISBANE (07) 5540 7530



Lens to suit 86200
86205



Len Stop Lamp Rear Combination
815610K400



Lens to suit 86710
86715



Lens to suit 86220
86225



Clear Lens Hella To Suit 2041
9204101



Lens Suits 2081/2082
9208201



Lens to suit 86070/8580
86075



Lens to suit 85950
85955



Clear Lens To Suit 86080
86085



Red Lens to suit 86100
86105



Amber Lens to suit 86100
86107



Lens to suit 86150
86155



Front Indicator Lens
2R0405



Lens
2R0406



Amber Rear Lens
2R0407



Clear Lens
2R0419



Clear Lens
2R0420



Red Rear Lens Lhs
2R0408LH



Red Rear Lens Rhs
2R0408RH



Clear Rear Lens
2R0409

WWW.MRFILTER.COM.AU

SYDNEY (02) 9769 1166

Mr Filter EST 1998
TRUCKING EARTHMOVING MINING
SUPPLIES

BRISBANE (07) 5540 7530



Front Indicator Assembly
2R0750



Stop/Tail/Indicator Light
93604BL



Lens to suit 86160
86165



Tail Light Lens
1R0406



Indicator Light Lens
1R0407



Lens
3R0409



Front Indicator Lens Vehicles
3R0414



Tail Light Lens
1R0412



Tail Light Lens
1R0413



Tail Light Lens
1R0414



Tail Light Lens
1R0415



Tail Light Lens
11R0405



Amber Indicator Lens
3R0405



Rear Tail Light Lens Kit
3R0406



Rear Reverse Lens
3R0407



Front Indicator Lens
3R0408



Front Indicator
2136



Stop/Tail/Indicator Light
86460BL



Narva Stop/Tail/Indicator
85700BL



Stop/Tail Light Incandescent
86470BL

WWW.MRFILTER.COM.AU

SYDNEY (02) 9769 1166

Mr Filter EST 1996
TRUCKING EARTHMOVING MINING
SUPPLIES

BRISBANE (07) 5540 7530



Rear Stop/Tail Direction Indicator
86710



Stop/Tail/Indicator Light
86710BL



Front Indicator/Park Light 12V L/H
95004



Front Indicator/Park Light 12V R/H
95006



Hella Lens Clear Amber
9EL964531-001



LED Tail Stop/Tail/Indicator Light
2072



Stop/Tail/Indicator Light Square
2082



Front Indicator Light 12 or 24V
2140



Front Indicator & Position Lamp
2141



Stop/Tail/Indicator/Licence Plate Light
2384



Stop/Tail/Indicator/Licence Plate
2388



Rear End Outline Marker + Rear
85820BL



Amber Lens to suit 85780
85785



Stop/Tail/Indicator Light
86010BL



Combo Rear Flasher/Park Lamp
86000BL



Red Led Rear End Outline Marker
69RM



Stop/Tail/Ind/Reverse/Licence Plate
2419



Stop/Tail/Indicator/Licence Plate Light
86030BL



Lens to suit 86030
86035



Red Lens
9238201

WWW.MRFILTER.COM.AU

Mr Filter EST 1998
TRUCKING EARTHMOVING MINING
SUPPLIES

SYDNEY (02) 9769 1166

BRISBANE (07) 5540 7530



Rear Tail Light Assembly
13R0703



Amber Lens to suit 86240
86245



Lens to suit 85790 Tail Light
85795



Pk 2 Led Stop/Tail/Ind/Reverse Lamp
ISL404RAW



Right Hand Front Indicator
3R0746



Front Door Indicator Lamp
3R0747



Holden Colorado Ute Rg Ute Tail
HL507112T



Holden Rodeo Tail Light
HLRD-TAL-96N



Led Stop/Tail/Ind/Reverse Lamp
LS9022



Front Indicator Lamp
2R0740



Tail Light Assembly Right
3R0703



Tail Light Assembly Left
3R0704



Lamp Assembly,Rear Room
8125095J05B4



Right Hand RH Indicator
1387155



Tail Light Assembly Isuzu
2R0707



Tail Lamp Assembly Isuzu
2R0708



Rear Tail Lamp Right Hand
815500K261



Lens & Body, Rr Combination
815510K261



Lamp Assembly Rear
815600K261



Lens & Body, Rr Combination
815610K261

WWW.MRFILTER.COM.AU

SYDNEY (02) 9769 1166

Mr Filter EST 1998
TRUCKING EARTHMOVING MINING
SUPPLIES

BRISBANE (07) 5540 7530



Led Stop/Tail/Indicator Lamp
LS9018



Led Stop/Tail/Indicator Lamp
LS9019



Tail Lamp Assembly Hilux
TY545112T



Rear Tail Light Hilux Aluminium
TY548112T



VOLKSWAGEN CADDY 2K Tail Light RH
VWCD-TAL-05R



Lamp Rr Combination
932U-QML250081



Lamp Asm; Rr Co
8980343250



Lamp Asm Rr Combination
8980343280

Truck and Trailer Reflectors & Lights - Reflectors



Amber Reflector 70Mmx30Mmx6Mm
7030A



Red Reflector 70Mmx30Mmx6Mm
7030R



White Reflector 70Mm X 30Mm X 6Mm
7030W



Clear Retro Reflector with Fixing Bolt
84000BL



Amber Retro Reflector with Fixing Bolt
84001BL



Red Retro Reflector with Fixing Bolt
84002BL



Clear Retro Reflector 65mm BL Pk 2
84005BL



Amber Retro Reflector 65mm BL Pk 2
84006BL



Red Retro Reflector 65mm BL Pk 2
84007BL



Clear Retro Reflector - Fixing Hole 60mm
84010BL



Amber Retro Reflector - Fixing Hole 60mm
84011BL



Red Retro Reflector - Fixing Hole 60mm
84012BL

WWW.MRFILTER.COM.AU

SYDNEY (02) 9769 1166

Mr Filter EST 1998
TRUCKING EARTHMOVING MINING SUPPLIES

BRISBANE (07) 5540 7530



Clear Retro Reflector - Fixing Hole 84mm
84020BL



Amber Retro Reflector - Fixing Hole 84mm
84021BL



Red Retro Reflector - Fixing Hole 84mm
84022BL



Reflector Rectangle Clear 40 x 90mm - 50 Pce
84030-50



Clear Retro Reflectors 90 x 40mm BL Pk 2
84030BL



Reflector Rectangle Amber 40x90mm - 50 Pce
84031-50

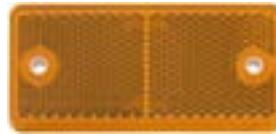

Amber Reflector 90 x 40mm BL Pk 2
84031BL



Reflector Rectangle Red 40 x 90mm - 50 Pce
84032-50



Red Reflector 90 x 40mm BL Pk 2
84032BL



Clear Reflector 70 x 28mm 50 Pce
84035-50



Clear Reflector 70 x 28mm BL Pk 2
84035BL



Amber Reflector 70 x 28mm BL Pk 2
84036BL



Red Reflector 70 x 28mm BL Pk 2
84037BL



Reflector Rectangle Clear 44 x 94mm
84050-50



Clear Reflector 94 x 44mm BL Pk 2
84050BL



Amber Reflector 94 x 44mm Pk 50
84051-50



Amber Reflector 94 x 44mm BL Pk 2
84051BL



Red Reflector 94 x 44mm Pk 50
84052-50



Red Reflector 94 x 44mm BL Pk 2
84052BL



Clear Reflector 105 x 55mm BL Pk 2
84060BL

WWW.MRFILTER.COM.AU

SYDNEY (02) 9769 1166

Mr Filter
EST 1998
TRUCKING EARTHMOVING MINING
SUPPLIES

BRISBANE (07) 5540 7530



Amber Reflector 105 x 55mm Pk 50
84061-50



Amber Reflector 105 x 55mm BL Pk 2
84061BL



Red Reflector 105 x 55mm Pk 50
84062-50

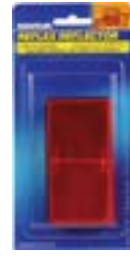

Red Reflector 105 x 55mm BL Pk 2
84062BL



Red Reflector in Plastic Holder
84082BL



Pkt 2 Amber Reflector Mounting Base
ISL820A



Red Reflex Reflector Pack of 20
ISL821RB



Amber Reflex Reflector Packet 20
LS9192



Reflector Amber Scania
2052117

Truck and Trailer Reflectors & Lights - Side Marker & Number Plate Lights



Led Licence Plate Lamp 12/24V
35BLM



Led Licence Plate Lamp 12/24V
35CLM



Licence Plate Light 12V
86060BL



Licence Plate Light 12V
86190BL



Licence Plate Light 12V
86540BL



Licence Plate Light 12V
86550BL



10-30V Model 8 Led Licence Plate
90862BL



10-30V Model 8 Led Licence Plate
90862CBL

WWW.MRFILTER.COM.AU



LED Licence Plate Light
BR15B



10-30V 6 LED Rectangle 81 x 41mm
BR25B



Lens To Suit 86700
86705BL



Lens To Suit 86710
86715BL



Amber Lens for 2140
9214001



Clear Lens for 2141
9214101



Front Indicator Lamp Assembly
11R0706



Grommet Rubber 135 Series
135G



Led Front Indicator Lamp
175AW-2



Led Front Direction Indicator
175AWTB2



Blinker Assy Bumper Left
1822102601



Blinker Assembly Fm8J Hino
1R0762IKP



LED Amber / Red Lamp
ISL430AR



Cab Marker Light Amber
2026HELLA



Side Marker Light Red/Amber
2053



Side Marker Light Red/Amber
2053GMD



Front Marker Light White Led
2059S



Front Marker Light Clear Led
2059SBULK



Front Marker Light Amber LED
2060S



Led 12/24 Slim Side Marker
2083SBULK

WWW.MRFILTER.COM.AU

SYDNEY (02) 9769 1166

Mr Filter EST 1996
TRUCKING EARTHMOVING MINING
SUPPLIES

BRISBANE (07) 5540 7530



Led Licence Plate Lamp
30BLM



Led Licence Plate Lamp
30CLM



Led Licence Plate Lamp 12/24V
60BLM



Led Licence Plate Lamp
41BLM



Led Rear End Outline Marker
42RM



Led Rear Position Marker Lamp
58RM



Lamp Side Direction
35AM



Led Red/Amber Side Marker
35ARM



Led Red/Amber Side Marker
35CARM



Lamp Position Marker Led 4 White
35WM



Led Amber Side Direct Indicator
42AM



Led Amber/Red Side Marker
42ARM



Led Front End Outline Marker
42WM



Led Supplementary Side Marker
5025AM2



Led Side Marker Lamp
5025ARM2



Led Side Direction Indicator
58AM



LEDAUT 10/30V Amber Side Marker
58AMB



Led Red Amber Side Marker
58ARM



Led Front Position Marker
58WM



Chrome Bracket To Suit 35 Series
35BCB

WWW.MRFILTER.COM.AU



Rear Marker Light Red LED
91632



91632BL



Led Rear End Outline Marker
HU9657



Led Front End Outline Marker
HU9658



Amber Led Side Marker
69AM



Amber/Red Led Side Marker
69ARM

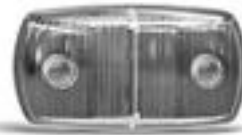

White Led Front End Outline Marker
69WM



Marker Lamp White LED
2035104



LED Strobe Amber 12 or 24V
85213A



LED Warning Lamp 12 or 24V
85215A



Red/Amber Led Side Marker Lamp
1004ARM



Side Marker Light Red/Amber
86720BL



Side Marker Light Red/Amber
86740BL



Side Marker and Front Position
85720



Side Marker Lamp (Red/Amber)
85750BL



Side Marker Lamp (Red/Amber)
85760



Side Marker Light Red/Amber
85770BL



Side Indicator Lamp
85780BL



Rear Stop/Tail Licence Plate
85840BL



Rear Marker Light Red
85870BL

WWW.MRFILTER.COM.AU

SYDNEY (02) 9769 1166

Mr Filter
EST 1996
TRUCKING EARTHMOVING MINING
SUPPLIES

BRISBANE (07) 5540 7530



Marker Lamp Amber
85871BL



Marker Lamp Green
85872BL



Marker Light Blue
85873BL



Front Marker Light Clear
85874BL



Side Marker Light Red/Amber
85880BL



Rear Marker Light Red
85890BL



Side Marker Light Amber
85900BL



Side Indicator Lamp
85940BL



Side Direction Indicator
86180



Amber Side Indicator
2127



Front Indicator Light Led 9 To 33V
2105



Front Marker Light Clear
86340BL



Cab Marker Light Amber
86350BL



Front Indicator & Position
87280



Clear Lens to suit 87280
87285



Led Amber Side Marker
86AM



Led Red/Amber Side
86ARM



Side Marker Lamp (Amber)
87140



Front Direction Indicator
87250



Clear Lens to suit 87260
87265

WWW.MRFILTER.COM.AU



Front Direction Indicator
87270



10-33 Model 52 Volt Led Front
95200



10-33V Model 52 Volt Led
95202



Led Front Directin Indicator
HU9650



Led Side Direction Indicator
77ACM2



Amber Led Side Marker
7922AM2



Led Side Marker Lamp
HU9655



10-33V Side Marker Lamp (Red/Amber)
91402BL



10-33V Side Marker Amber
91422BL



Side Marker Light Red/Amber
91602



Side Marker Light Red/Amber
91602BL



9-33V Side Marker Lamp (Red/Amber)
91603



Front Marker Light Clear
91612



Front Marker Light Clear
91612BL



Front Marker Light Amber
91622BL



Licence Plate Lamp
91664BL



9-33V 3 Led Licence Plate
91666BL



9-33V 5 Led Licence Plate
91674



9-33V 3 Led Licence Plate
91680



Chrome Deflector Mounting Base
91689

WWW.MRFILTER.COM.AU

SYDNEY (02) 9769 1166

Mr Filter EST 1996
TRUCKING EARTHMOVING MINING
SUPPLIES

BRISBANE (07) 5540 7530



Black Deflector Mounting Base
91690



Low Profile Licence Plate Housing
91698



Side Marker Light Amber
91800



13-30V Led Side Marker Amber
92002



12V Sealed Side Indicator
93002



Trucklite Model 10 Side Marker
93052



Side Marker Light Red/Amber
93110BL



Side Blinker/ Indicator 9-33V
93212



Side Direction Indicator
93302



9/30V Led Mdl34 Lamp
93404BL



Led Supplementary Side Marker
EU38AMHD



Led Front End Outline Marker
EU38WMHD



12V Sealed Side Indicator
93002



Trucklite Model 10 Side Marker
93052



Side Marker Light Red/Amber
93110BL



Side Blinker/ Indicator 9-33V
93212



Side Direction Indicator
93302



9/30V Led Mdl34 Lamp
93404BL



Led Supplementary Side Marker
EU38AMHD



Led Front End Outline Marker
EU38WMHD

WWW.MRFILTER.COM.AU



Whitevision Side Marker
95-SM62RALED



Led Strip Rev Light For Licence
95070



12 Volt Model 54 Combined Led
95410



Side Indicator Lamp LED
96052



Amber Lens Guard Indicator
3R0416



Led Twin Function Side
97AIM



Led Twin Function Side
97ARIM



Led Twin Function Front
97WIM



Led Twin Function Rear
97RIM



Oval Chrome Side Marker
91494



Led Rear Position Marker Lamp
35RM



Rear Marker Light Red LED 9 to 33V
2307



10-30V Oval 60 x 30mm Clear Lens
BR2AR



LED Clearance Light Amber
BR3A



10-30V Led Oval Marker
BR3ARL



LED Amber Clearance Lamp
BR4A



LED Red Clearance Lamp
BR4R



LED White Clearance
BR4W



Front Marker Light Clear
86080BL



Front Indicator & Position Light
2070HELLA

WWW.MRFILTER.COM.AU

SYDNEY (02) 9769 1166

Mr Filter EST 1996
TRUCKING EARTHMOVING MINING
SUPPLIES

BRISBANE (07) 5540 7530



Front and Side Direction
85930BL



Amber Side Direction Indicator
38AMB



Led Front Direction Indicator
2109V-24V



Lamp Assembly Side Turn
8974101804



Lamp; Turn Sign
8981554580



Side Marker Amber/Red
LMX21500



Led Licence Plate Lamp
LP1LED



Led Front Direction Indicator
LS9033



12V Chrome Number Plate
NG8127029255



LED Side Marker Amber/Red
VX603AR

UHF Radios and Accessories - AM/FM Radios



Radio 12V Watertight Plant & Marine
MA1500BT



Bluetooth Cd/Mp3 Multimedia
AX1502BT



AM/FM Radio Receiver 12/24v
AX1800BT



AM/FM Radio Bluetooth Mechless
AX1801BT



12/24 Volt CD & AM/FM Multimedia
AX1802BT



12/24V Bluetooth Dvd/Cd Multimedia
AX1803BT



12/24V 3 Lcd Mechless With Bluetooth
AX1805BT



6.8" Double Din Head Unit
AX1807BT

WWW.MRFILTER.COM.AU



6.8" Mechless Apple Carplay Headunit
AX1870CP



Bluetooth Dab/Dab+/Fm Radio
JBLTUNER2BLK



Waterproof Marine Am/Fm Radio
GR300BTB



Universal Pocket Snap-in
FP9014



Fascia with Pocket Toyota Ford
FP9016



2-Din Media Receiver+Usb Smart Phone
KWM150BT



Marine Am/Fm Radio With Usb
MA1801



Marine Am/Fm Radio With Usb
MA1802



18V Li-ion Cordless Jobsite Radio
W117092



18V Li-Ion Worksite Radio & Charger
W164655

UHF Radios and Accessories - Antenna



AM/FM Black Helical Antenna
FM1



Am/Fm Replacement Mast
FM1A



Antenna 15Cm Flexible Black Pvc
AE4002



380Mm Flexible Antenna
AE4005



Antenna 38Cm Flexible
AE4013



850Mm Elevated-Feed Antenna
AE4018K



970Mm Elevated-Feed Antenna
AE4018K1



Antenna 104Cm (6.6Dbi Gain)
AE4702B

WWW.MRFILTER.COM.AU

SYDNEY (02) 9769 1166

Mr Filter EST 1999
TRUCKING EARTHMOVING MINING
SUPPLIES

BRISBANE (07) 5540 7530



Antenna Randomome Fibreglass
AE4703B



580Mm Hd Radome Antenna
AE4704B



Antenna 120Cm (6.6Dbi Gain)
AE4705B



2.5Db On-Glass Mount UHF Antenna
AE5003



Antenna Kit
AK3



4.5Db UHF Antenna Kit
AK4



5Db Black 720Mm Uhf Antenna
AK5R



Lazer Digital Antenna Kit
AKDTV



6.5DBI HD Spring Antenna
ANU230



Oricom 6db Aerial Kit
ANU400



Top Mount Rubber Antenna
AP102



450 Mm Antenna With Base,Cable & Plug
AE312V



Nissan Patrol Pathfinder Mast
AP272



Deluxe Active Roof Antenna
AR100



Short Rubber Antenna 29cm
AT2



Uhf Antenna Kit 3Dbi
AT380



6Dbi Flexible Kit Whip
AT480



6.6Dbi Elevated Feed Kit
AT840



6.6dB Black HD Antenna Kit
AT890BK



6.6dbi Radome Antenna Kit
ATX890

WWW.MRFILTER.COM.AU



13cm Unity Gain Aerial Antenna
AW1



4.5Db 64cm UHF Antenna
AW4



2.1dbi UHF Antenna Whip
AW4704B



Antenna Uhf 4.5Db
AW4S



4.5Db Black Uhf Antenna
AW4SB



6Db Uhf Full Braid Whip 1.2M
AW6



Vhf Marine Antenna Kit 1.1M
MFV3



5db White 720mm UHF Antenna
CH5TW



Antenna Kit Uhf 6Db Flexible
CH6BK



7-9Dbi Mobile Antenna
CLR8



Mobile Network Radome Antenna
CLR85G



30cm Uhf Antenna
F477A



Am/Fm Antenna 1.53M
SW2A



Audio Extra Telstra Antenna
CEL-FIGOTANT



Radio Aerial Antenna For FTR32
2V9902



Glass Mount UHF Antenna
AK25GM23

UHF Radios and Accessories - Antenna Accessories



Axis Water/Dust Proof Receiver
AT1900BT



Axis Water/Dust Proof Receiver
AT1901BT



Axis Z Bracket Stainless
BB4SS



Fold Down UHF Aerial
MBU-05BK

WWW.MRFILTER.COM.AU

SYDNEY (02) 9769 1166

Mr Filter
EST 1998
TRUCKING EARTHMOVING MINING
SUPPLIES

BRISBANE (07) 5540 7530



Black Abs Microphone Holder
MH3B



Microphone Holder
MH801

UHF Radios and Accessories - Speakers



Bose S1 Pro System with Battery
340343



PartyBox Go Portable Speaker
490593



Sennheiser Wireless Headphones
508384



Sennheiser Voice Cancel Headphones
508386



Evolve2 65 MS Bluetooth Headset
EVOLVE265



Wireless Noise Cancelling Headphones
WHCH710NB



5" 3-Way Slimline Speakers
AX5036



4" 4-Way Quadaxial 4-Way speakers
BGX1404



6.6" 2-Way Component Speakers
BGX1662C



6.6" 4-Way Quad-Axial System
BGX1664



4" 2 Way Boxed Speakers
AX442



4" 2-Way Marine Box Speakers
MA442



5" Marine Speakers-White
MA500W



2-Way Coaxial Speakers
MA6902



Communication Extension Speaker
CB27



Boulder + BT Speaker
ECOBOULDERPLUS

WWW.MRFILTER.COM.AU



Trek BT Speaker
ECOTREK



Edge BT Speaker - Black
ECOEDGEBLK



Edge BT Speaker - Blue
ECOEDGEBLU



Bluetooth Speaker & Worklight
SP81400



Lcd Microphone - Tx3340 / Tx3345 / Tx3540
MC534B



Lcd Microphone - Tx3350 / Tx3550S
MC634B



Controller Microphone XRS-330C Variants
MC664B



Midland Waterproof Speaker
MA25M



Marine Box Speaker
SPK006



4" Bracket Mount Speaker
SPK006W



4" 2-Way Coaxial Speaker
XR42



6" 2-Way Coaxial Speaker
XR62



10" Amplified 100 RMS Subwoofer
XT1110A

UHF Radios and Accessories - UHF Accessories



UHF Microphone Hand Piece
2U0169



Speaker Microphone Suit UHF CB Radio
MC007



Electret Microphone Suits Tx3100
MC301B



Electret Microphone Suits TX3120S
MC311B

WWW.MRFILTER.COM.AU

SYDNEY (02) 9769 1166

Mr Filter
EST 1998
TRUCKING EARTHMOVING MINING
SUPPLIES

BRISBANE (07) 5540 7530



Electret Replacment Microphone
MC516B



Heavy Duty Microphone
mc553b



HD Microphone - Tx3500S/TX3200
MC557B



Oricom Microphone
MIC050



Replacement Microphone
MIC110



Microphone Suits Uhf300
MIC300



Uniden 4P Microphone-Tone Call
MK485



Uniden Uh089 Microphone
MK677



Uniden Microphone RJ45
MK770



UHF CB Radio Microphone
MK800



Long Range Wireless Dect Speaker
MK800W



Uniden Microphone for UHF Radio
MK840WP



Speaker Microphone for CB Radio
MK900



Mini Compact Hybrid UHF/CB + Remote
ML802



Uhf Cb/Lmr With Remote Speaker
PRO902



Remote Lcd Microphone/ Handpiece
RM-980



Remote LCD Speaker Microphone
RM800



Oricom SM5100 Speaker Microphones
SM5100



HD Speaker Mic
SPKMIC5000



Speaker Mic To Suit Uhf5500-1
SPKMIC5500

WWW.MRFILTER.COM.AU



Lock Screw Throat Mic
THMIC5000



UH5000 + Antenna Mini Compact
UH5000ANT



Microphone MK901 w RJ45 Connector
MK901



In Car Accesory Kit To Suit UHF Radio
ACC6160CK



Razer Seiren BT Bluetooth Microphone
587874



Ap1 Universal Pillar Antenna
AP1



Replacement Antenna - Suit UHF Radio
AE4021



10m Extension Cable (4-PinF/4PinM)
AX10M-4P



Charger For Handheld Uhf Cb Radio
BCV007



Commercial Quality Earpiece
EM800



VHF Fixed Mount Marine Radio
GX700W



Cable Adaptor Axis
HDC-F-F



50Mm Black SS Bullbar Mount
BB50B



63Mm Wrap Around Bull Bar
BB63W



Gme Microphone Bollard
46A1024



134Mm Magnet Aerial Mount
AM107



Mirror Mount/Roof Bar Bracket
MM1



Axis Uhf Double Female
PL258



Axis Uhf Male Coaxial
PL259



Uhf Din Mounting Facia
DMK8990

WWW.MRFILTER.COM.AU

SYDNEY (02) 9769 1166

Mr Filter EST 1998
TRUCKING EARTHMOVING MINING
SUPPLIES

BRISBANE (07) 5540 7530



Toyota RJ45 Uhf Face Plate White Illum
CBRJ45FP



Magnetic Microphone Mount Black
MB207



Rj45 Type 1 Pass Through Adaptor
XRS-RJ45W1



Rj45 Type 2 Pass Through Adaptor
XRS-RJ45W2



Rj45 Pass Through Universal Adaptor
XRS-RJ45RND



Holder Metal Microphone Cb/Uhf
MH2

UHF Radios and Accessories - UHF Radio



Micro 5 Watt UHF CB Radio
DTX4300



Micro 5 Watt UHF CB Radio COMBO
DTX4300PK



Value Pack- Dtx4300 Uhf Cb Radio
DTX4300VP



Midland 5Watt Uhf-Cb Radio + Antenna
HM477ANT



Midland Pro901 Machinery Pack
MACHINERYPACK



Uniden 5 Watt Vhf Marine Radio
MHS127



0.5W Twin Pack UHF CB Radio
PM795BL



UHF Radio Twin Pack 0.5w
PMR795



Uhf Cb Radio Plug and Play Windscreen
PNP-KIT



Uhf Cb Radio 5Watt Transceiver
TX3100



5 Watt Super Compact UHF CB Radio
TX3100DP



5 Watt UHF Two Way CB Radio
TX3100VP

WWW.MRFILTER.COM.AU



Super Compact 5 Watt UHF CB
TX3120S



UHF CB Radio With SoundPath
TX3350



Uhf Cb Radio With Scansuite
TX3500S



UHF CB radio With Antenna
TX3500SVP



Micro Dsp Uhf Radio With Remote
TX3520S



5 Watt Uhf Cb Radio - Lcd Speaker
TX3550



Mobile Two Way Radio
TX3600



5 Watt Din Mount Uhf Cb Radio
TX4500S



Uhf Cb Radio 80 CH 5 Watt
TX4610



5 Watt Uhf Cb Radio Premium Unit
TX6160



5 Watt Orange Uhf Cb Radio Pk2
TX6160OTP



5 Watt Uhf Cb Radio Pk2
TX6160TP



5 Watt UHF CB Radio Pk2
TX6160YTP



5/1 Watt IP67 UHF CB Radio
TX6600S



1 Watt UHF CB Radio
TX667



2 Watt Uhf Cb Radio Quad Pack
TX677QP



2 Watt UHF CB Radio Pk2
TX677TP



Mini Compact Size UHF CB
UH5000



5W Uhf Mobile Radio Din
UH5050



Mini Compact Size UHF CB Mobile
UH5060

WWW.MRFILTER.COM.AU

SYDNEY (02) 9769 1166

Mr Filter EST 1998
TRUCKING EARTHMOVING MINING
SUPPLIES

BRISBANE (07) 5540 7530



Mini UHF with Remote Mic Value Pack
UH5060VP



UHF 1 Watt CB Handheld 2-Way Pk2
UH510-2



UHF CB Mobile Radio 80 Channel
UH6000



UHF With Remote Speaker
UH6060



Mini Size UHF CB Mobile + Antenna
UH8010S-ANT



Mini Compact Size UHF CB Mobile
UH8060S



80 Channels 2 Watt UHF Radio
UH820S



2 Watt UHF Radio Twin Pack
UH820S-2



2W UHF CB Radio Adventure Pack
UHFAP2190



2W UHF Twin Tradie Pack
UH825-2TP



5w Handheld UHF 2220mAh
UH850S



5 Watt UHF CB - Tradies Pack
UH850S-2TP



5W Uhf CB Yellow Radio
UH850Y



Mini Compact Size UHF CB Mobile
UH9000



Mini Compact UHF CB Mobile
UH9060



Uhf Cb Adventure Pack
UH9060ADV



Mini UHF + Antenna + Mount Bracket
UH9060ANT



Mini Compact UHF CB Mobile
UH9080



5W UHF CB Handheld Radio
UH950S



5W UHF CB Radio + Antenna Value Pack
UHF300PK

WWW.MRFILTER.COM.AU



5W CB Radio with Controller
UHF390



UHF Radio Controller Speaker Mic
UHF390VP230



5W UHF Radio 12/24v
UHF400R



2W UHF CB Radio Twin Pack
UHFTP2190



2W UHF CB Radio Trade Pack
UHFTP2390



VHF Splashproof Marine Radio
UM355VHF



VHF In-Boat Marine Radio
UM455VHF



XRS Uhf Radio CB Bluetooth
XRS-330C



Uhf Cb Radio Connect Outback Pack
XRS-330COB



XRS Uhf Radio Portable Pack
XRS-330CP



XRS Connect Compact UHF CB Radio
XRS-370C



XRS Connect 4WD Pack
XRS-370C4P



XRS Connect 4WD Outback Pack
XRS330COB



XRS Uhf Radio Touring Pack
XRS-330CTP



5W Smart UHF Handheld Radio
XTRAK50-0



Xtrak 80 Uhf Kit
XTRAK80



XTRAK 80 Adventure Pack
XTRAK80ADV



Mini Compact UHF CB Mobile
XTRAK40

WWW.MRFILTER.COM.AU

SYDNEY (02) 9769 1166

Mr Filter EST 1998
TRUCKING EARTHMOVING MINING
SUPPLIES

BRISBANE (07) 5540 7530